



EVER (325,650,1000,1500,2000,2500,3000,4000)
Ceiling Type Energy Recovery Unit (Cellulosic Exchanger)



Assembly & Maintenance Guide



EN

Introduction	Page 1
Warnings & Safety Informations	Page 2
Check List	Page 3
Technical Specifications	Page 4
Unit Dimensions	Page 4
Installation	Page 5
Selection of Electrical Cable Cross-Section	Page 7
Maintenance	Page 8

INTRODUCTION

Installation&Operation Manual has been prepared and given to customer as a guide for easy installation&operation units manufactured by ENEKO A.Ş. The manual contains description of the unit, components and basic informations and recommendations for proper and fail free operation. Please read the instructions and warnings given in this manual before starting installation, operation and maintenance works and keep this manual near the unit, within easy reach of service personnel.



Any damage, failure or hazard occurred because of use except this purpose is beyond the responsibility of manufacturer.



For technical service and questions, please contact with following information.



+90 232 328 20 80 / 103-152



+90 536 713 10 00



www.eneko.com.tr



servis@eneko.com.tr

WARNINGS & SAFETY INFORMATION



PROHIBITED

- ◆ This unit has to be used under proper conditions according to its technical specification and design purpose. (Otherwise responsibility belongs to practitioner)
- ◆ Unauthorized personnel must not interfere in unit and/or must not use unoriginal spare parts. (Otherwise responsibility of failure that may occur belongs to practitioner)
- ◆ Do not install this product in a refrigerated warehouse, heated swimming pool or other location where temperature and humidity are significantly different. (Failure to heed this warning may result in electrical shock or malfunctioning.)
- ◆ Do not install this product where it will be directly exposed to rain. (Failure to heed this warning may result in electrical shock or malfunctioning.)
- ◆ Do not install this product in a location where acid, alkali or organic solvent vapors, paints or other toxic gases, gases containing corrosive components or high concentrations of oily smoke are present (Failure to heed this warning may result not only in malfunctioning but also fire, power leakage and electrical shock.)
- ◆ Do not use this product outside the range of its rated voltage and control capacity.



ATTENTION

- ◆ Install this product in an environment where the temperature ranges from -10 °C to +40 °C and the relative humidity is less than 60%. If condensation is expected to form, heat up the fresh outside air by a duct heater etc.
- ◆ Select an adequately sturdy position for installing the product and install it properly and securely.
- ◆ Use the designated electrical wires for the terminal board connections and connect the wires securely so that they will not be disconnected. (Failure to ensure proper connections may result in fire.)
- ◆ When passing metal ducts through wooden buildings clad with metal laths, wire laths or metal, these ducts must be installed in such a way that they will not make electrical contact with metal laths, wire laths or metal sheets. (Power leakage can cause ignition.)
- ◆ The outside ducts must be tilted at a gradient (1/30 or more) downwards toward the outdoor area from the main unit, and properly insulated. (The entry of rain water may cause power leaks, fire or damage to household property.)
- ◆ Gloves should be worn while installation. (Failure to heed this warning may result in injury.)
- ◆ A dedicated circuit breaker must be installed at the origin of mains power supply. This circuit breaker must be provided with a means for locking (lock and key).
- ◆ The body of the unit, room control panel and cables keep away the unit 3 m. distance.



- ◆ This product must not be disassembled under any circumstances. Only authorized repair technicians are qualified to conduct disassembly and repairs. (Failure to heed this warning may result in fire, electrical shock or injury.)



- ◆ Connect the product properly to the ground. (Malfunctioning or power leaks can cause electrical shock.)



- ◆ An isolator switch having minimum contact gap of 3 mm in all poles must be provided as a means of disconnecting the power supply.

NOTE: The installations, which is not available for installation and operation manual, is out of guarantee.

CHECK LIST

In the event of unit failure and pre-commissioning checks to be made are determined as follows; after checking this information, please contact our company in case failure continues.

Controls

√

Make sure that the unit receives power and electrical grounding is made!

Make sure that the electricity cables are drawn from in the correct cross section!
(Please check whether there is heating on cables or not.)

Please check whether the cables in unit control panel are shielded (shielded magnetic field) or not; make sure shielding is grounded. If not, please change them!

Make sure that fresh air and exhaust air filters are clean and they do not block the flow of air!

Make sure there is the connection of drainage on the unit, check any possible clogging in drainage line and clean if necessary!

Please check whether the diameter of the air duct connection of the unit and the diameter of the spigot are the same. If the duct connection is smaller, change it with the correct one.

Make sure the electrical connections of the unit are made as suggested on the unit and in this guide, check if there is incorrect connection.

Make sure during the installation of the unit there is enough space for the service and if there is not enough space, re-install again.

In extremely cold climate applications, frost may occur on the exchanger, apply electric heater in fresh air intake section of the unit to get the temperature to -5 °C and above.

After installing the unit, make sure that it does not create an abnormal sound or vibration, if there is, make sure that rubber pads are used.

TECHNICAL SPECIFICATIONS

	EVER 325	EVER 650	EVER 1000	EVER 1500	EVER 2000	EVER 2500	EVER 3000	EVER 4000
Air Flow* (m³/h)	400	640	1060	1480	2050	2550	3250	5000
Supply Voltage (V/Hz/Ph)	230 / 50 / 1 ~							
Max. Power Consumption(W)	170	244	350	688	810	810	1040	2640
Operation Current (A)	0.74	1.08	1.54	3.02	3.84	3.84	4.58	11.78
Max. Sound Pressure**(dB)	35	36	36	41	45	49	50	52
Unit Weight (kg)	36.5	50	84	102	118	122	225	280
Filter Class	ISO Coarse Filter According to ISO 16890							

* External static pressure 0 Pa.

** Measured at 1,5m distance to the unit @ 250 Hz.

UNIT DIMENSIONS

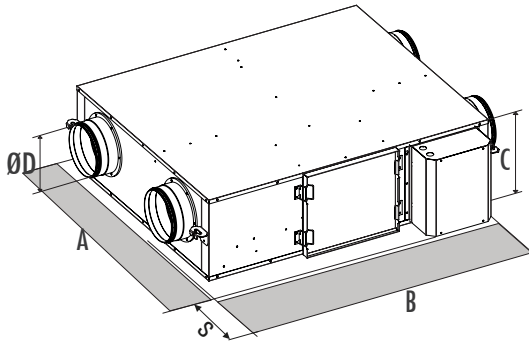

	A	B	C	ØD	S
EVER 325	890	1100	285	160	700
EVER 650	800	1315	350	200	600
EVER 1000	1050	1270	350	250	600
EVER 1500	1310	1290	350	250	600
EVER 2000	1260	1790	470	300	700
EVER 2500	1600	1835	470	355	700
EVER 3000	1730	2300	600	500x400 800x400	1100
EVER 4000	1800	2300	600	550x450 800x450	1100

* All measurement values are mm.

The gaps of the maintenance area values are specified as "S" on the table. ("Installation" is on page 5.)

INSTALLATION

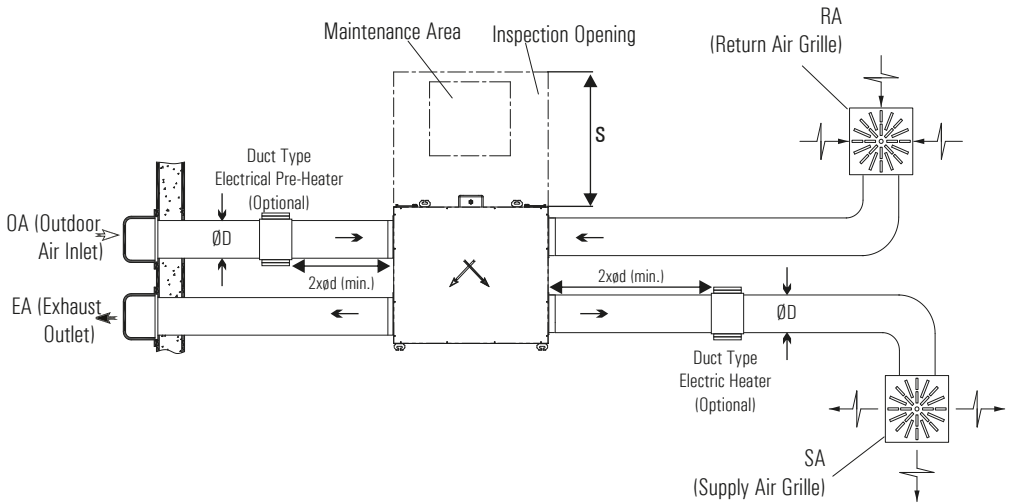

NOTE: Top view. Fan access panels are under the unit. *The gaps of the maintenance area are specified as "S" on the technical picture. ("Unit Dimensions" is on page 4.)

! CAUTION	Extremely Sharp Bends	Multiple Bends	Bends right next to the outlet	Extreme Reduction in the diameter of the connected ducts
Check these warnings before installation.				

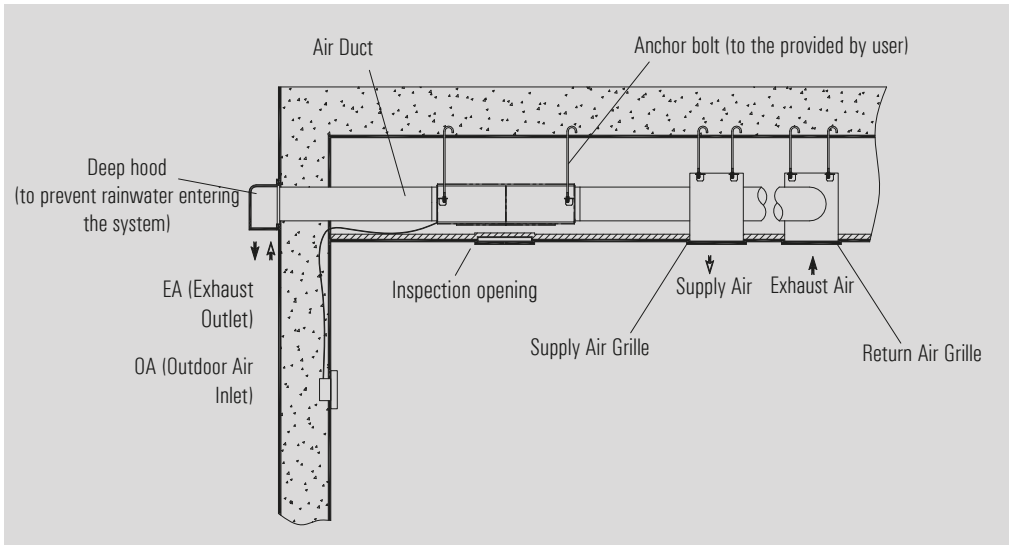

Preparing The Sling Bolts

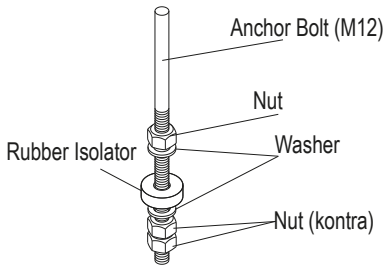

Hang the suspension bracket on the anchor bolts and adjust in such a way that the unit is installed horizontally. Tighten up securely using double nuts in order to prevent looseness.

! WARNING

Check the stability of sling bolts during the installation.

Attaching The Duct Connection Flanges

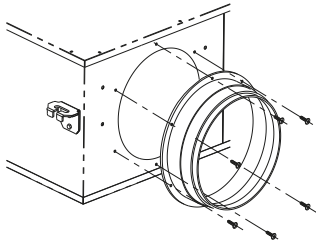

If the duct connection flanges are not connected to the unit, use the screws that can be found in the installation package to connect the flanges to the unit as the figure on the left.

! WARNING

Before attaching the duct connection flanges, check that no foreign matter has found.

Installation Of The Unit

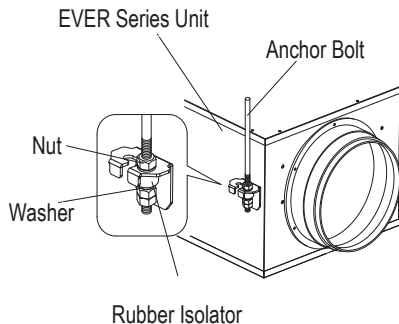

Hang the unit on the anchor bolts and adjust in such a way that the unit is installed horizontally. Tighten up securely using double nuts in order to prevent looseness.

! WARNING

Do not handle the unit in such way that force will be applied to the control box when suspending the main unit from the ceiling.

SELECTION OF ELECTRICAL CABLE CROSS-SECTION

Unit Model	Unit Voltage (V)	Unit Power Input (kW)	Current (A)	Fuse (A)	Cable Cross-Section(mm ²) for 50M and PF=0.8
EVER					
325	230	0.17	0.74	1	1.5
650	230	0.24	1.08	2	1.5
1000	230	0.35	1.54	2	1.5
1500	230	0.69	3.02	4	2.5
2000	230	0.81	3.84	5	2.5
2500	230	0.81	3.84	5	2.5
3000	230	1.04	4.58	6.3	2.5
4000	230	2.64	11.78	16	4

The data in the table shows the maximum power/current values. Please check unit label for updated values.

Cable Cross-Section Formulas

1

$$I_{\text{current}} = \frac{P}{U \cdot \cos\phi}$$

$$I_{\text{cable}} > I_{\text{current}}$$

2

$$\%e = \frac{100 \cdot P \cdot L}{k \cdot S \cdot U^2}, S = \frac{100 \cdot P \cdot L}{k \cdot \%e \cdot U^2}$$

$$\%e = \%3$$

3

$$I_{\text{cable}} > I_{\text{fuse}} \geq I_{\text{current}}$$

$$\text{Cable Cross-Section } S = \text{Max } (S1, S2, S3, 1.5\text{mm}^2)$$

P : Power

I : Current

U : Voltage

S : Conductor cross section

k : Conductor coefficient

L : Conductor length

%e: The voltage drop

Example of Cable Cross-Section Calculation

P : 2,6 kW

L : 50m

U : 230V

%e : %3

PF : Cosφ : 0,8

k : 56m / Ω

1

$$I_{\text{current}} = \frac{2600 \text{ W}}{230 \cdot 0,8} = 14.2 \text{ A}$$

The cable will be used, is selected from the cable cross-section table so that the equivalent ampere value in the table should be higher than calculated "I_{current}" value.

$$S1 = 1.5 \text{ mm}^2$$

2

$$\%e = \%3$$

$$S = \frac{100 \cdot 2600 \cdot 50}{56.3 \cdot 230^2} = 1.46 \text{ mm}^2$$

$$S2 \geq 1.46 \text{ mm}^2 \geq 1.5 \text{ mm}^2$$

$$S2 = 1.5 \text{ mm}^2$$

3

$$I_{\text{cable}} > I_{\text{fuse}} \geq I_{\text{current}}$$

$$I_{\text{cable}} > 16\text{A} \geq 14.2\text{A}$$

"I_{fuse}" which will be higher than "I_{current}", is selected.

The cable will be used, is selected from the cable cross-section table so that the equivalent ampere value in the table should be higher than selected "I_{fuse}" value.

$$I_{\text{cable}} = 24\text{A}$$

$$S3 = 1.5 \text{ mm}^2$$

$$\text{Cable cross-section } S = \text{Max } (S1, S2, S3, 1.5 \text{ mm}^2)$$

$$S = \text{Max } (1.5, 1.5, 1.5, 1.5)$$

$$S = 1.5 \text{ mm}^2$$

- ◆ TURN OFF all the power switches before the maintenance is performed.
- ◆ Do not operate the system without the air filter to protect the components of the unit against being clogged.
- ◆ Clean up the air filter more than once in a year.
- ◆ Clean up the heat exchanger more than once per year.

Heat Exchanger Cleaning

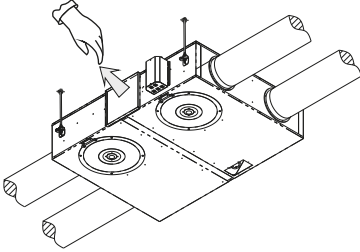

Step 1: Remove the exchanger's service cover, then remove the heat exchanger out from the main unit.

Note: The maximum weight of heat exchanger is 10 kg.

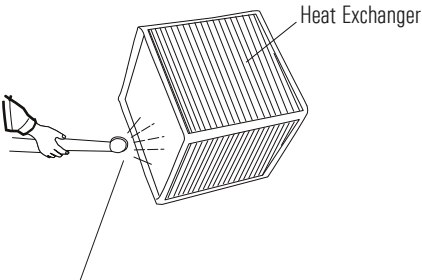

Clean using vacuum cleaner

Step 2: Cellulosic heat exchanger can be cleaned by using vacuum.

Air Filter Cleaning

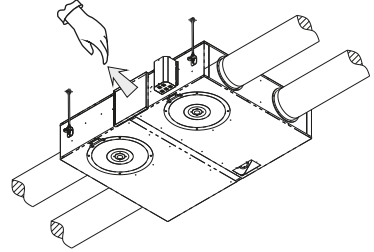

Step 1: Open the filter service cover. Remove the air filters from the unit.

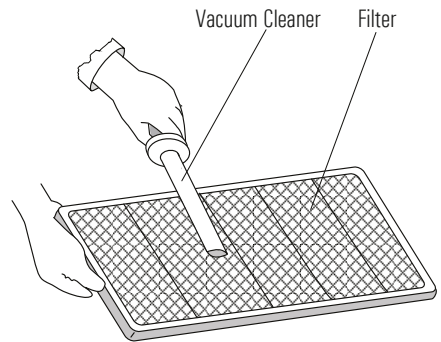

Step 2: Use a vacuum cleaner to remove the dust from the air filter. If necessary, use warm water with addition a house detergent to remove the persistent dirt. Leave to dry after cleaning the air filter. Connect the unit after making sure that the filter has dried.



Warranty Certificate

- * If the unit is used according to the instructions given in user manual and interfered in only authorized technical service that we authorize about any maintenance and repair reasons, all spare parts will be under warranty for 2 years against material, labor and production faults except motor components.
- * Identifying of parts replaced and determining troubleshooting technical procedure applied, will belong to our company.
- * After ex-works of goods, all faults during loading, unloading and shipment will be out of guarantee. If a falsify has been made on documents or any falsify and changing have been made on serial number, goods will be out of guarantee.

Terms of Guarantee

1. Guarantee period is 2 years as from the time of delivery.
2. All spare parts except motor components are under warranty.
3. If the goods break down during guarantee period, the time spent for maintenance will be added to guarantee period. Maintenance period is 30 days at most. 30 days begin with the notice to a service station. If there is no service station, 30 days begin with the notice to the seller, dealer, agency, agent, importer or manufacturer of the goods.
4. If production fault occurs during guarantee period; the cost of new spare part and labor will not be claimed from the customer.
5. If a fault occurs because of not using or assembling according to the instructions given in user manual, goods will be out of guarantee.

UNIT TYPE

SERIAL NO

ENEKO Havalandırma ve İsi Ekonomisi
Sistem Teknolojileri Makina San. ve Tic. A.S.
10049 Sokak No: 04 AOSB Cigli/İZMİR
Tel: 0.232.328 20 80
Web Address: www.eneko.com.tr

SIGNATURE:



www.eneko.com.tr

ISTANBUL

 Cevizli District, Zuhul Avenue, Fusun Street, Ritim Istanbul
A5 Block Floor: 25 No: 137, 34846 Maltepe/Istanbul - TURKEY

 +90 216 455 29 60 / +90 216 455 29 61

 +90 216 455 29 62

 satis@eneko.com.tr

IZMIR

 10049 Street No: 4 I.A.O.S.B.
Cigli/Izmir - TURKEY

 +90 232 328 20 80

 +90 232 328 20 22

 info@eneko.com.tr



ENECON PLUS



Automation User Manual



Introduction	Page 1
Warning & Safety Information	Page 2
Enecon Plus Standard Panel	Page 3
Control	Page 3
Fault List	Page 8
Warning List	Page 8
Service Menu Usage	Page 9
MODBUS RTU Settings	Page 9
MODBUS Register List	Page 10
Control Systems	Page 16

INTRODUCTION

This Automation User Manual has been prepared for the correct installation and use of the control systems of the units manufactured by ENEKO A.Ş. The Automation user manual contains description of the unit, components and basic informations and recommendations for proper and fail free operation. Please read the instructions and warnings given in this manual before starting installation, operation and maintenance works and keep this manual near the unit, within easy reach of service personnel.



Any damage, failure or hazard occurred because of use except this purpose is beyond the responsibility of manufacturer.



For technical service and questions, please contact with following information.



+90 232 328 20 80 / 103-152



+90 536 713 10 00



www.eneko.com.tr



servis@eneko.com.tr



PROHIBITED

- ◆ This unit has to be used under proper conditions according to its technical specification and design purpose. (Otherwise responsibility belongs to practitioner)
- ◆ Unauthorized personnel must not interfere in unit and/or must not use unoriginal spare parts. (Otherwise responsibility of failure that may occur belongs to practitioner)
- ◆ Do not use this control system other than the operating conditions specified in the installation and maintenance manual of the device. Do not use this control system in environments exposed to rain. (Otherwise, it may cause electric shocks or malfunction of the device)
- ◆ Do not use this unit in acid, alkali or organic solvent vapors, paint or other toxic gases, gases containing corrosive substances, or in environments with high concentrations of oily smoke. Failure to heed this warning may result not only in the control system malfunctioning, but also in fire, electric leakage, and electric shock.



ATTENTION

- ◆ The relevant connection diagram is on the cover of the panel.
- ◆ Use the designated electrical wires for the terminal board connections and connect the wires securely so that they will not be disconnected. (Failure to ensure proper connections may result in fire.)
- ◆ In the ducts passing through the building, in the parts of the ducts that are in contact with the building construction, make sure that the ducts are not in any electrical contact with the metal parts. (Electric leaks can cause fire and explosion.)
- ◆ Gloves should be worn while installation. (Failure to heed this warning may result in injury.)
- ◆ A dedicated circuit breaker must be installed at the origin of mains power supply. This circuit breaker must be provided with a means for locking (lock and key).
- ◆ The unit, the room control panel and cables must be at least 3 meters away from equipment or cables that create a high electromagnetic field. (Otherwise it may cause the device not to work.)
- ◆ During the replacement of spare parts, the layout of the panel must be maintained and the part must be assembled as it came from the factory.



This product must not be disassembled under any circumstances. Only authorized repair technicians are qualified to conduct disassembly and repairs.
(Failure to heed this warning may result in fire, electrical shock or injury.)



Connect the product properly to the ground. (Malfunctioning or power leaks can cause electrical shock.)



An isolator switch having minimum contact gap of 3 mm in all poles must be provided as a means of disconnecting the power supply.

NOTE: The installations, which is not available for installation and otomation manual, is out of guarantee.

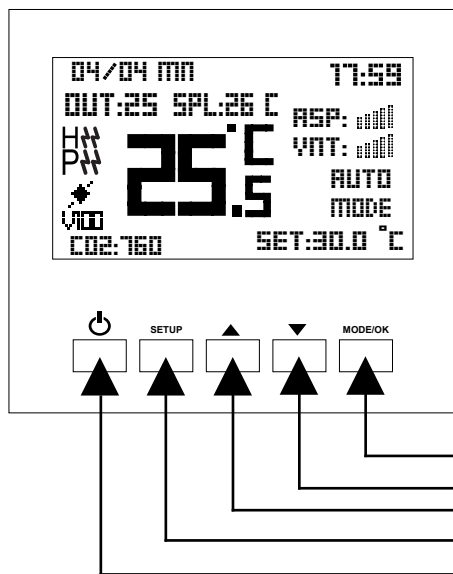

- 3.1" Graphic Panel
- Aspirator, Ventilator 6 Level Speed Control
- Automatic / Manual Mode
- Heating / Cooling / Fan Mode
- Language Option
- Internal Return Air Temperature Input
- Minimum & Maximum Set Temperature Limit
- Weekly Program

Mode/Ok
Down
Up
SetUp
On/Off

Technical Specifications

Environmental Specifications	
Operating, Stock Temperature	0 ... +50°C (There should be no icing or condensation in the environment.)
Electrical Specifications	
Control	Digital Wall Panel (Max. 30 m) / Building Automation
Relay Current Capacity	Resistive 5A (Heater Contactor)
Supply	230V AC Outputs

CONTROL

Fan Speed Control Function

Control board has 7 different fan speeds. These fan speeds are set to specific values by default. The maximum fan speed is "boost". If it is desired to change fan speeds, set values can be changed by control panel and service menu parameters. If the device is on and in manual or fan mode, it is brought to the state that ASP or VNT is flashing by pressing **Mode/OK** button and ASP, VNT level is adjusted with ▲ and ▼ buttons.

Service parameter:

- 3 Aspirator Fan Manual Speed Value
- 4 Ventilator Fan Manual Speed Value

Mode Selection

- Mode selection can be made by pressing the **Mode/OK** button on the panel when the device is on.
- If the device is in Manual Heating or Automatic Heating, the set temperature is selected by pressing **Mode/OK**.
- In the manual heating and automatic heating mode, if the **Mode/OK** button is pressed while in the set temperature setting section, the next mode is entered directly.
- If the device is in Automatic mode, you can switch to the next mode by pressing **Mode/OK**.

Temperature Settings

- If the device is in manual or automatic heating mode when the device is on, the set temperature is set to flash by pressing the **Mode/OK** button and the set temperature is adjusted with the **Up** and **Down** buttons.
- If the device is in manual or automatic heating mode when the device is on, the set temperature is set to flash by pressing the **Mode/OK** button and the set temperature is adjusted with the **Up** and **Down** buttons.

Filter Function (Optional)



This function controls filter change time. There are 2 alternatives to control filters:

1. It records run time of the unit. Filter change time is set a particular run time by factory settings. When set time expires, control board gives an alert (red warning light flashes) for filter change.

Note: The instant filter time can be monitored from Parameter 115.

2. Filter change time can be controlled by pressure switch mechanically. With this method, when filter needs to be changed, control board gives an alert.

By-pass Function (Optional)

	By-pass is off.
	By-pass is on.

By-pass function only exists on units which have by-pass module. It is used when filtered fresh air is desired to be supplied to indoor without passing through heat exchanger (transition seasons). Control board decides whether by-pass module will be opened or not by controlling outdoor air temperature, return air temperature and set temperature values.

Note: By-pass status can be monitored from the 44th parameter of the service menu (0: Closed / 1: Open)

Electrical Pre-heater Function (Optional)

It is used to prevent icing inside the device in regions where the outside temperatures are very low. It works gradually depending on the outside temperature. The opening temperature of the preheater is set to 0 °C by default. It can be changed in the service menu.

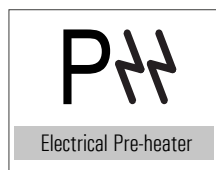

Note1: If a pre-heater is connected, the terminals specified in the electrical diagram of the device can be used directly. In order to receive the electric preheater alarm, the connection must be made by removing the jumper at the relevant terminal.

Note2: Pre-heater step can be monitored from the 63th parameter of the service menu. The heater thermostat information can be monitored from the 20th parameter.

Electric Heater Control Function (Optional)

Electric heater control function only exists on units which have duct type electric heater. This function controls electric heater that is used to increase temperature of supply air. It runs due to the return air temperature and set temperature values. 1 or 2 steps electric heater can be controlled.

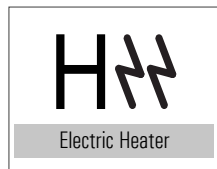

Note1: If an electric heater is connected, the terminals specified in the electrical diagram of the device can be used directly. In order to receive the electric preheater alarm, the connection must be made by removing the jumper at the relevant terminal.

Note2: Electric heater step can be monitored from the 62th parameter of the service menu. The heater thermostat information can be monitored from the 20th parameter.

Heating Coil Function (Optional)

This function is used in units which have duct type hot water coils. It controls the hot water coil which helps to increase supply air temperature and works due to set and return air temperature. It can control 230V On/Off valve connected to water coil. It can also control proportionally.

Note: H100 / V100 indicates that 100% output is given to the heating coil.

Cooling Coil Function (Optional)

This function is used in units which have duct type cold water coils. It controls the cold water coil which helps to decrease supply air temperature and works due to set and return air temperature. It can control 230V On/Off valve connected to water coil. It can also control proportionally.

Note: C100 / V100 indicates that 100% output is given to the cooling coil.

Frost Protection Function (Optional)

Condensation occurs inside the unit where outdoor air temperature is below 0°C. Heat exchanger can be damaged if condensation water freezes inside. Control board changes fan speed periodically to protect freezing. When the temperature drops below the specified value, one or more of the following scenarios can be used;

1. The speed of the blower fan can be reduced (Parameter 518),
2. It will be active if there is a pre-heater (Parameter 513),
3. It will be active if there is a by-pass. (Parameter 160-153).

Bms Function (Optional)

BMS Function makes the unit to be monitored on a central automation system. Terminals on the control board can be used for the BMS connection.

Boost Function

It is used to provide for high amounts of exhaust and fresh air that will occur due to any effects that may occur in the environment (such as bad smell in the kitchen, using the bathroom and / or toilet) while the device is operating in any location. When **BOOST** mode is activated, the fans are fully operated. After working for the specified **BOOST** time, the device continues to operate normally.

1. **BOOST** terminals can be used as shown in the electrical diagram (optional)
2. It can be activated using parameter 117 of the service menu.

Note: BOOST time can be changed.

Fire Function (Optional)

There is a dry contact relay on the control board. The fire function is activated in case of on fire, if the dry contact relay is attached to fire system.

Note : Fire scenario can be selected from parameter 144 of service menu.

Sensor (VOD) (Optional)

It operates with CO₂, air quality or humidity sensor connection. Fan speeds are automatically changed according to the data from these sensors.

Note: The sensor value can be monitored from the service menu and panel screen:

- 27 Humidity Value
- 28 Air Quality Value
- 29 CO₂ Value parameters
- 38 CO₂ Set Value
- 39 Humidity Set Value

Note: If a CO₂ sensor will be added when the unit is in the field, the following parameters must be changed.

Parameter	Description	CO ₂ Config. Value
381	Analog Input 1 Type Selection	1
321	Analog Input 1 Min Value	0
331	Analog Input 1 Max Value	2000
530	Humidity control Open/Close	0
38	CO ₂ set value	0..2000
102	Full auto mod	1
529	CO ₂ control type	2
114	Analog value screen	1

Note: If a humidity sensor will be added when the unit is in the field, the following parameters must be changed.

Parameter	Description	Hum. Config. Value
381	Analog Input 1 Type Selection	3

Parameter	Description	Hum. Config. Value
321	Analog Input 1 Min Value	25
331	Analog Input 1 Max Value	155
530	Humidity control Open/Close	1
39	Humidity set value	0..100
114	Analog value screen	3

Date and Time Settings

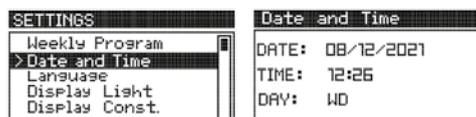

- While the device is on, press the Setup button on the panel for 2 seconds.
- Select Date Time Setting with the Down button and press the **Mode/OK** button.
- Select the day, month and year setting with the **Up and Down** button and proceed using the **Mode/OK** button.
- Select the hour and minute settings with the **Up and Down** buttons and proceed using the **Mode/OK** button.
- Select the day with the **Up and Down** button and scroll using the **Mode/OK** button and turn **On/Off** Exit with the button.

Weekly Program Settings

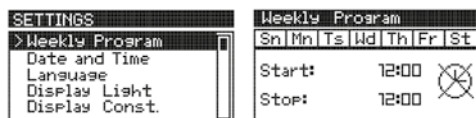

Weekly timer function is available on Panel. Unit can be programmed to operate automatically on certain periods of the week.

- While the device is on, press the Setup button for 2 seconds on the panel, while the weekly program is selected, press the **Mode/OK** button.
- Select the day to be adjusted by using the **Up and Down** buttons and the **Mode/OK** button.
- While Start is written, the start time of the device is set. Proceed with the **Mode/OK** button and set the end time of the device when Stop is written and save with the **Mode/OK** button.
- The same process steps are repeated for the other days, and the start and end times are adjusted as desired.
- After the weekly program is made, it is returned to the main screen with the **On/Off** button.

Note 1: If the start time is after the endtime, the device remains off during the selected day.

Note 2: If the start time and end time are the same, the weekly program application will not work for the selected day.

Note 3: If the device has a weekly program setting for the current day, the clock logo appears on the screen and operates with in the programmed working hours.

Note 4: If the device is programmed weekly for the current day and is within the programmed working hours, the clock stop logo appears on the screen.

 : The weekly program is active and the device stops.

 : The weekly program is active.

The Key Lock/Unlocked



- The key lock is unlocked by pressing the **Setup** and **Down** button for 5 seconds in the open position.
- If you want to close the key lock, the key lock is turned off by pressing **Setup** and **Down** again for 5 seconds.

Fault Reset Setting

If the fault code flashes in the upper corner of the screen and the fault is fixed, the fault is reset by pressing the **Setup** button and **Up** button at the same time while the screen is on.

Note: Before resetting the filter dirty alarm, the filter must be changed by the technical service.

FAULT LIST

Value		Binary	Explanation
E	1	0000.0000.0000.0001	Aspirator Fan Failure
E	2	0000.0000.0000.0010	Vantilator Fan Failure
E	4	0000.0000.0000.0100	Electrial Heater Failure
E	8	0000.0000.0000.1000	Aspirator Air Flow Error
E	16	0000.0000.0001.0000	Vantilator Air Flow Error
E	32	0000.0000.0010.0000	Compressor Failure
E	64	0000.0000.0100.0000	Low Pressure
E	99	-	Communication Error
E	128	0000.0000.1000.0000	High Pressure
E	256	0000.0001.0000.0000	Fire Alarm
E	1024	0000.0100.0000.0000	VRF Error

WARNING LIST

Value		Binary	Explanation
W	1	0000.0000.0000.0001	Closed By Building Automation System
W	2	0000.0000.0000.0010	Boost Mode
W	4	0000.0000.0000.0100	Filter 1 Dirty
W	8	0000.0000.0000.1000	Filter 2 Dirty
W	16	0000.0000.0001.0000	Defrost Mode
W	32	0000.0000.0010.0000	Freezing Thermostat
W	64	0000.0000.0100.0000	Emergency
W	4096	1000.0000.0000.0000	Maintenance Alarm

To log in to the user service menu:

- Press the **Up** and **Down** buttons simultaneously through the panel while the device is energized.
- On the screen you see, use the **Up** and **Down** buttons to enter the service password and press the **Mode/OK** button.

Note: The service password: "58"

- If the password is entered correctly, enter the parameter number you want to change on the display and press the **Mode/OK** button.
- After changing the parameter you want to change, register by pressing the **Mode/OK** button and go to the main menu with the **On/Off** button.
- Press the **On/Off** button to exit the service menu.



Changes to be made in the service setting menu must be made by the relevant technical personnel. All responsibility arising from these changes belongs to the person who changed the device parameter.

MODBUS RTU SETTINGS

To log in to the user service menu:

- Press the **Up** and **Down** buttons simultaneously through the panel while the device is energized.
- On the screen you see, use the **Up** and **Down** buttons to enter the service password and press the **Mode/OK** button.
- If the password is entered correctly, enter the parameter number you want to change on the display and press the **Mode/OK** button.
- After changing the parameter you want to change, register by pressing the **Mode/OK** button and go to the main menu with the **On/Off** button.
- For Modbus ID, the "PR" parameter is reached 111, and using the desired Modbus ID **Up** and **Down** buttons, set "ST" and press the **Mode/OK** button.
- For Modbus ID, the "PR" parameter is reached 112, and using the desired Modbus baudrate **Up** and **Down** buttons, set "ST" and press the **Mode/OK** button.
- Press the **On/Off** button to exit the service menu.

0: 1200 Bps

1: 2400 Bps

2: 4800 Bps

3: 9600 Bps

4: 19200 Bps

5: 38400 Bps

6: 57600 Bps

Note 1: All Modbus parameters are Holding register.

Note 2: All Modbus parameters are Signed Integer 16.

MODBUS REGISTER LIST

PLC Register				
40001	0	Device Open / Close Variable	0...1	0: Off 1: On
40002	1	Device Set Temperature	0...999	280 value means 28 °C.
40003	2	Device Air Conditioning Mode	0...5	0: Fan Mode 1: Man. Heating 2: Man. Cooling 3: Auto Heating 4: Auto Cooling 5: Full Automatic Mode
40004	3	Aspirator Fan Manuel Speed Value	0...6	
40005	4	Ventilator Fan Manual Speed Value	0...6	
40007	6	Panel Ambient Temperature Value	-400...999	It is the Temperature Value on the Panel.
40008	7	Device Fresh Air Temperature Value	-400...999	It shows the temperature of the air drawn in the space.
40009	8	Device Supply Air Temperature Value	-400...999	If there is no temperature value available on the device, the temperature value is seen as "32767".
40010	9	Outdoor Temperature Value	-400...999	
40011	10	Water Coil Temperature Value	-400...999	
40015	14	Bms Input	0...1	0: Device Operates Normally., 1: The device is turned off.
40016	15	Boost Input	0...1	0: It works normally., 1: Fans are working fully.
40017	16	Aspirator Fan Air Flow Information	0...1	Aspirator Fan Air Flow Switch information.
40018	17	Ventilator Fan Air Flow Information	0...1	Ventilator Fan Air Flow Switch information.
40019	18	Filter 1 Dirty Information	0...1	Filter 1 DPS State
40021	20	E. Heater Safety Thermostat Information	0...1	Safety Thermostat Information
40022	21	Aspirator Fan Thermal Fault Information	0...1	Aspirator Fan Fault Information
40023	22	Ventilator Fan Thermal Fault Information	0...1	Ventilator Fan Fault Information
40024	23	Emergency Stop Button Information	0...1	Emergency Stop Button Information
40025	24	Low Pressure Inlet Information	0...1	Low Pressure Input
40026	25	High Pressure Information	0...1	High Pressure Input
40027	26	Fire Information	0...1	Fire Entry
40028	27	Freezing Thermostat Information	0...1	Freezing Thermostat Information (In Water Coil application, the valve opens completely and the fans are completely turned off.)
40029	28	Compressor Thermal Failure Information	0...1	Compressor Thermic (If there is a compressor, the compressor turns off.)

MODBUS REGISTER LIST

PLC Register				
40030	29	Phase Fail Information	0...1	Phase Failure Information (The device is completely turned off.)
40031	30	Heat Exchanger Freezing Thermostat	0...1	
40034	33	Humidity Value	0...1000	This value is adjusted according to the analog input calibration parameter between 321 and 340.
40035	34	Air Quality Value	0...1000	
40036	35	CO ₂ Value	0...1000	
40037	36	Return Pressure Value	0...1000	
40038	37	Blowing Pressure Value	0...1000	
40039	38	Analog 1 Set Value		
40040	39	Analog 2 Set Value		
40044	43	Fresh Air / Suction Damper Motor	0...1	0: Off 1: On
40045	44	By-pass Damper Motor	0...1	0: Off 1: On
40046	45	Heating / Cooling Coil Valve Output	0...1	0: Off 1: On
40047	46	Heating Battery Open / Close Output	0...1	0: Off 1: On
40048	47	Cooling On / Off Battery Outlet	0...1	0: Off 1: On
40049	48	Compressor Output	0...1	0: Off 1: On
40050	49	Compressor 4 Way Valve Output	0...1	0: Off 1: On
40051	50	Device Operation Information Output	0...1	0: Off 1: On
40052	51	Device Fault Information Output	0...1	0: Off 1: On
40053	52	Device Warning Information Output	0...1	0: Off 1: On
40054	53	Aspirator Fan Run Output	0...1	0: Off 1: On
40055	54	Ventilator Fan Run Output	0...1	0: Off 1: On
40059	58	Rotary Outlet	0...1	0: Off 1: On
40061	60	Instant Aspirator Fan Output Value	0...6	Fan electric heater shows the instantaneous step value.
40062	61	Instant Ventilator Fan Output Value	0...6	
40063	62	Instant Electric Heater Value	0...3	
40064	63	Instant Pre Electric Heater Value	0...3	
40065	64	Aspirator Fan Analog Output Value	0...100	It shows the proportional output values.
40066	65	Ventilator Fan Analog Output Value	0...100	
40067	66	Proportional Heating Valve Output Value	0...100	
40068	67	Proportional Cooling Valve Output Value	0...100	
40069	68	Proportional Heating / Cooling Valve Output Value	0...100	
40070	69	Proportional By-pass Damper Output Value		

MODBUS REGISTER LIST

PLC Register					
40073	72	Start on Sunday Hour: Minutes	0...2359	The device operates between the start and end times within a day and the device switches off outside these hours. If the start and end times are equal, the device works continuously on that day. If the start time is more than the end time, the device is completely turned off on the day set. The set parameter is 1210 è Hour: Minute information is set as 12:10.	
40074	73	Ending on Sunday Time: Minutes	0...2359		
40075	74	Start on Monday Hour: Minutes	0...2359		
40076	75	Ending on Monday Time: Minutes	0...2359		
40077	76	Start on Tuesday Hour: Minutes	0...2359		
40078	77	Ending on Tuesday Time: Minutes	0...2359		
40079	78	Start on Wednesday Hour: Minutes	0...2359		
40080	79	Ending on Wednesday Time: Minutes	0...2359		
40081	80	Start on Thursday Hour: Minutes	0...2359		
40082	81	Ending on Thursday Time: Minutes	0...2359		
40083	82	Start on Friday Hour: Minutes	0...2359		
40084	83	Ending on Friday Time: Minutes	0...2359		
40085	84	Start on Saturday Hour: Minutes	0...2359		
40086	85	Ending on Saturday Time: Minutes	0...2359		
40087	86	Instant Day	1...31		
40088	87	Instant Month	1...12		
40089	88	Instant Year	0...99		
40090	89	Instant Hour	0...23		
40091	90	Instant Minute	0...59		
40092	91	Instant Second	0...59		
40093	92	Instant Day of the Week	1...7	1: Sunday 2: Monday 3: Tuesday 4: Wednesday 5: Thursday 6: Friday 7: Saturday	
40094	93	Instant Weekly Program Status	0...2	0: No Weekly Schedule 1: The device has a weekly program and the device is working. 2: The device is set up weekly and the device is stopped.	
40096	95	Alarm Value	0...99		
40097	96	Warning Value	0...99		
40104	103	Keylock	0...1	0: Key Lock Off, 1: Key Lock On	
40105	104	Major Fault Information	0...1	0: No Fault, 1: The device has been completely shut down.	
40106	105	Compressor Failure Information	0...1	0: No fault in the compressor 1: There has been a fault that turns off the compressor.	

MODBUS REGISTER LIST

PLC Register				
40109	108	Fan Quantity	1...2	1: Single Fan, 2: Double Fan
40110	109	Fan Step Value	1...6	
40112	111	Modbus ID	1...254	
40113	112	Modbus Baudrate	0...7	
40114	113	Monitoring Temperature Value	0...3	0: Do not Show 1: Outdoor Temp. 2: Supply 3: Two Temp.
40115	114	Analog Input Value	0...3	0: Do not Show 1: CO ₂ 2: Air Quality 3: Humidity
40116	115	Filter Time Counter	0-9999 Hour	This counter increases on an hourly basis as long as the Ventilator Fan is running.
40117	116	Device Operating Mode Information	0-100	0: Device Off, 1: Damper Opens, 2: The Fan Turns On, 3: Main Loop, 4: Valve Closes 5: Fan Turns Off, 6: Freezing Condition 7: Defrost Status, 99: Fault Status (Waiting forReset)
40118	117	Activate Boost	0-1	0: Deactivated, 1: Active
40119	118	Control Temperature Type	0-3	0: Panel Temperature 1: According to the Return Air Temperature 2: According to the Supply Temperature 3: According to Outside Air Temperature
40145	144	Fire Scenrio	0-3	0: Fans Off 1: ASP Full VNT Off 2: ASP Off VNT Full 3: 2 Fan Full On
40146	145	Heating Cooling Hysterezis	0-999	
40149	148	Boost Max. Operating Time	0-999 Min.	Boost turns off automatically after this time.
40150	149	Limiting Variable of Heater According to Fan	0-1	
40151	150	Pre heater On Time	1-999 Sec.	Pre-heater on delay time
40152	151	Pre heater Off Time	1-999 Sec.	Pre-heater off delay time
40153	152	Pre-heater Hysterezis	1...100	E.g; A value of 100 means 10.0 °C.
40154	153	Pre-heater Stage Ranges		
40155	154	Number of Pre-heater Stages	0-3	
40156	155	Heater On Time	1-999 Sec.	Heater on delay time

MODBUS REGISTER LIST

PLC Register				
40157	156	Heater Off Time	1-999 Sec.	Heater off delay time
40158	157	Heater Hysterezis	1...100	E.g; A value of 100 means 10.0 °C.
40159	158	Heater Stage Intervals		
40160	159	Number of Heater Stages		
40161	160	Pre-heater Set Temperature Value	-400...999	
40162	161	By-pass Hysterezis	1...999	
40163	162	Rotary Hysterezis	1...999	
40164	163	P Value for Valve PI control		
40165	164	I Value for Valve PI control		
40174	173	Heating Coil Freeze Protection Minimum Temperature Value	-400...999	Battery temperature in the Heating Coil If the sensor is below this temperature value it goes into freeze protection mode.
40175	174	Heating Coil Freeze Protection Maximum Temperature Value	-400...999	Battery temperature in the Heating Coil sensor during freeze protection if this freezing above the temperature value exits the protection mode.
40176	175	Heat Exchanger Freeze Protection Minimum Temperature Value	-400...999	Heat exchanger temperature sensor on the heat exchanger if it goes below this temperature value, the heat exchanger enters the frost protection mode with the bypass damper.
40177	176	Heat Exchanger Freeze Protection Maximum Temperature Value	-400...999	Heat exchanger temperature sensor on the heat exchanger While in frost protection mode, if the temperature rises above this value, the heat exchanger exits the frost protection mode.
40178	177	Filter protection warning time limit	1...9999	If the filter counter time exceeds this value gives a filter warning on the screen.
40182	181	1 Universal input status	-400...999	If one of the device's universal input digital inputs is selected, 0 or 1 appears in the register. 0: On 1: Off
40183	182	2 Universal input status	-400...999	
40184	183	3 Universal input status	-400...999	
40185	184	4 Universal input status	-400...999	
40186	185	5 Universal input status	-400...999	If one of the device's universal input digital inputs is selected, 0 or 1 appears in the register. 0: On 1: Off
40187	186	6 Universal input status	-400...999	
40188	187	7 Universal input status	-400...999	
40189	188	8 Universal input status	-400...999	
40202	201	1 Digital output status	0...1	

MODBUS REGISTER LIST

PLC Register			
40203	202	2 Digital output status	0...1
40204	203	3 Digital output status	0...1
40205	204	4 Digital output status	0...1
40206	205	5 Digital output status	0...1
40207	206	6 Digital output status	0...1
40208	207	7 Digital output status	0...1
40209	208	8 Digital output status	0...1
40222	221	Analog Input 1 status	-9999...9999
40232	231	Analog Output 1 status	-9999...9999
40233	232	Analog Output 2 status	-9999...9999
40234	233	Analog Output 3 status	-9999...9999
40235	234	Analog Output 4 status	-9999...9999
40262	261	Din 1 Input Normally Open/Closed Selection	0...1
40263	262	Din 2 Input Normally Open/Closed Selection	
40264	263	Din 3 Input Normally Open/Closed Selection	
40265	264	Din 4 Input Normally Open/Closed Selection	
40266	265	Din 5 Input Normally Open/Closed Selection	
40267	266	Din 6 Input Normally Open/Closed Selection	
40268	267	Din 7 Input Normally Open/Closed Selection	
40269	268	Din 8 Input Normally Open/Closed Selection	
40302	301	Din 1 Output Normally Open/Closed Selection	0...1
40303	302	Din 2 Output Normally Open/Closed Selection	
40304	303	Din 3 Output Normally Open/Closed Selection	
40305	304	Din 4 Output Normally Open/Closed Selection	
40306	305	Din 5 Output Normally Open/Closed Selection	
40307	306	Din 6 Output Normally Open/Closed Selection	
40308	307	Din 7 Output Normally Open/Closed Selection	
40309	308	Din 8 Output Normally Open/Closed Selection	
40361	360	Modbus Data Bit	0...1
40362	361	Modbus Parity	0...1
40363	362	Modbus Stop Bit	0...1

Universal inputs should be checked from the project and which input is used for what purpose.

Digital outputs should be checked from the project and which input is used for what purpose.

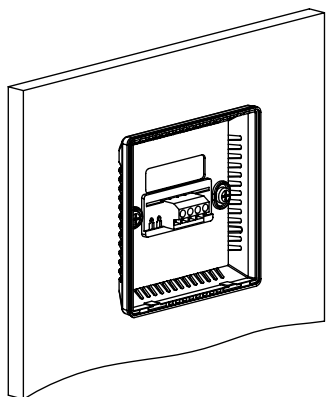

- With the help of a screwdriver, the back side is removed by pushing the tabs at the bottom of the panel.
- It is fixed to the wall with screws from the gaps on the plate.
- Bolts in $\varnothing 4 \times 30$ sizes and plastic dowels in $\varnothing 6$ sizes should be used.

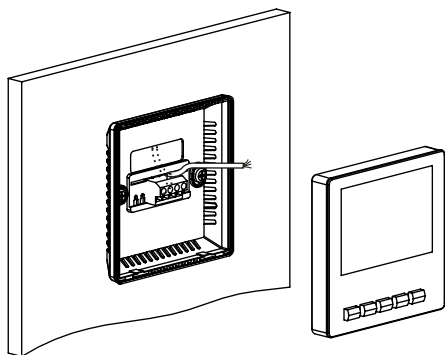

- The cable carried through the wall is passed through the cable gap on the back.
- Terminal connections related to the cable passed are made.
- First, the upper tabs on the front are replaced on the back.
- Afterwards, pressure is applied to the front of the panel so that the lower tabs on the front face are inserted into their places on the back.

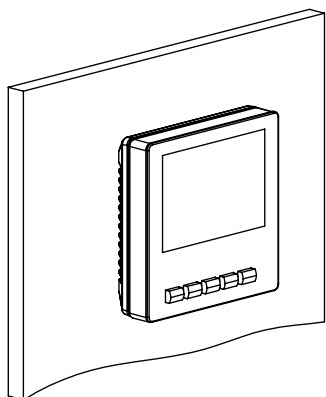

- The panel will be energized while the device is operating. Otherwise, the cable connections should be checked.



www.eneko.com.tr

ISTANBUL



Cevizli District, Zuhul Avenue, Fusun Street, Ritim Istanbul
A5 Block Floor: 25 No: 137, 34846 Maltepe/Istanbul - TURKEY



0216 455 29 60 - 0216 455 29 61



0216 455 29 62



satis@eneko.com.tr

IZMIR



10049 Street No: 4 I.A.O.S.B.
Cigli/Izmir - TURKEY



0232 328 20 80



0232 328 20 22



info@eneko.com.tr



REGIN (Corrigo Ardo)



Automation User Manual

Introduction	Page 1
Warnings & Safety Informations	Page 2
Display & Buttons	Page 3
Menu Structure & Features	Page 7
Functions	Page 13
Accessories	Page 15
Communications	Page 18

INTRODUCTION

This Automation User Manual has been prepared for the correct installation and use of the control systems of the units manufactured by ENEKO A.Ş. The Automation user manual contains description of the unit, components and basic informations and recommendations for proper and fail free operation. Please read the instructions and warnings given in this manual before starting installation, operation and maintenance works and keep this manual near the unit, within easy reach of service personnel.



Any damage, failure or hazard occurred because of use except this purpose is beyond the responsibility of manufacturer.



For technical service and questions, please contact with following information.



+90 232 328 20 80 / 103-152



+90 536 713 10 00



www.eneko.com.tr



servis@eneko.com.tr

WARNINGS & SAFETY INFORMATION



PROHIBITED

- ◆ This unit has to be used under proper conditions according to its technical specification and design purpose. (Otherwise responsibility belongs to practitioner)
- ◆ Unauthorized personnel must not interfere in unit and/or must not use unoriginal spare parts. (Otherwise responsibility of failure that may occur belongs to practitioner)
- ◆ Do not use this control system other than the operating conditions specified in the installation and maintenance manual of the device. Do not use this control system in environments exposed to rain. (Otherwise, it may cause electric shocks or malfunction of the device)
- ◆ Do not use this unit in acid, alkali or organic solvent vapors, paint or other toxic gases, gases containing corrosive substances, or in environments with high concentrations of oily smoke.
Failure to heed this warning may result not only in the control system malfunctioning, but also in fire, electric leakage, and electric shock.



ATTENTION

- ◆ The relevant connection diagram is on the cover of the panel.
- ◆ Use the designated electrical wires for the terminal board connections and connect the wires securely so that they will not be disconnected. (Failure to ensure proper connections may result in fire.)
- ◆ In the ducts passing through the building, in the parts of the ducts that are in contact with the building construction, make sure that the ducts are not in any electrical contact with the metal parts. (Electric leaks can cause fire and explosion.)
- ◆ Gloves should be worn while installation. (Failure to heed this warning may result in injury.)
- ◆ A dedicated circuit breaker must be installed at the origin of mains power supply. This circuit breaker must be provided with a means for locking (lock and key).
- ◆ The unit, the room control panel and cables must be at least 3 meters away from equipment or cables that create a high electromagnetic field. (Otherwise it may cause the device not to work.)
- ◆ During the replacement of spare parts, the layout of the panel must be maintained and the part must be assembled as it came from the factory.



- ◆ This product must not be disassembled under any circumstances. Only authorized repair technicians are qualified to conduct disassembly and repairs.
(Failure to heed this warning may result in fire, electrical shock or injury.)



- ◆ Connect the product properly to the ground. (Malfunctioning or power leaks can cause electrical shock.)



- ◆ An isolator switch having minimum contact gap of 3 mm in all poles must be provided as a means of disconnecting the power supply.

NOTE: The installations, which is not available for installation and otomation manual, is out of guarantee.

DISPLAY & BUTTONS



Standard Panel







PLC with display

Technical Data	Panel	PLC
Protection class	IP30	IP20
Ambient temperature	5...40°C	0...50 °C
Storage temperature	-40... +50°C	-20... +70 °C
Ambient humidity	5...95 % RH	Max 95 % RH
Port type (or Connection type)	26AWG /4P4C quick connection	RS485 / Ethernet
Communication speed	--	9600 baud (1200...76800 baud)
Supported protocols	--	EXoline-TCP / Modbus-TCP / BACnet/IP

The display has 4 rows of 20 characters each. It has background illumination. The illumination is normally off, but is activated as soon as a button is pressed. The illumination will be turned off again after a period of inactivity.

Leds

Symbol	Colour	Function
	Flashing red	There are one or more unacknowledged alarms.
	Fixed red	There are one or more remaining acknowledged alarms.
	Flashing yellow	You are in a dialog box where it is possible to switch to change mode. A quick blinking (2 times/s) indicates that the parameter can be changed using the current access level. A slower blinking (1 time/s) indicates that a higher access level is required to change the parameter.
	Fixed yellow	You are in change mode.

Status indication

Designation	Colour	Description
P1 RxTx	Yellow/Green	Port 1, receiving/transmitting
P2 RxTx	Yellow/Green	Port 2, receiving/transmitting
TCP/IP (...W models)	Yellow/Green	Green: Connected to other network equipment Blinking green: Network traffic Blinking yellow: For identifying (for example when marking the unit in Application tool)
P/B (Power/Battery)	Yellow/Green	Power on / Battery error

Status indication

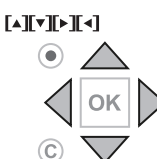
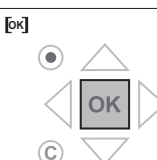
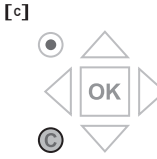
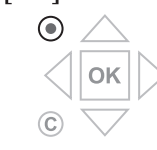
Buttons	Functions	Functions in Alarm mode
	<p>Navigation buttons:</p> <ul style="list-style-type: none"> ▲ Navigate upwards. ▼ Navigate downwards. ▶ Navigate to the right. ◀ Navigate to the left. <p>In change mode:</p> <ul style="list-style-type: none"> ◀ Move cursor to the left. ▶ Move cursor to the right. ▲ Increase the value by 1. ▼ Decrease the value by 1. ▲ and ▼ Scroll among the texts when there are several alternatives 	<ul style="list-style-type: none"> ▲ Navigate up in the alarm stack. ▼ Navigate down in the alarm stack. ◀ Exit alarm display mode.
	<ul style="list-style-type: none"> ✓ Enter change mode. ✓ Confirm a new value in change mode. An input must be confirmed with this button in order to change the value in the controller. When a value has been confirmed, the cursor will move to the next editable value in the current box. 	<ul style="list-style-type: none"> ✓ A menu with all actions that are available for the current alarm is displayed.
	<ul style="list-style-type: none"> ✓ Enter change mode and erase the value in the display. ✓ Erase the sign at the cursor. ✓ When the current value is completely empty, the edit mode is cancelled and the cursor will move to the next value that will also be erased in the window. ✓ Undo (erase) the input 	
	<ul style="list-style-type: none"> ✓ Enter alarm display mode. 	<ul style="list-style-type: none"> ✓ Browse among alarms in alarm display mode.

Navigating the menus

The appearance of the start display may vary since there are several different start displays to choose from during configuration.

Vent controller 5.0
 2017-07-08 14:29
 System: Normal run
 Sp: 22.0 Act: 22.5 °C

Sp and **Act** stand for Setpoint and Actual value.

Actual value = the current measured temperature

Setpoint = the desired configured temperature

You can navigate through the menu choices at this level by pressing the [▼] and [▲] buttons. Which menu items that are shown depends on the access level of the user and the configured inputs/outputs and functions.

Below, all possible menu entries are shown.

- ✓ Ventilation
- ✓ Additional function
- ✓ Time settings
- ✓ Alarm events
- ✓ Configuration
- ✓ Access rights

To enter a higher menu level, press the [▶] button when the display marker is located at the menu item you wish to enter. At each level there may be several new menus through which you may browse using the [▲] and [▼] buttons. When there are further submenus linked to a menu or menu item, it is indicated by an arrow symbol at the right-hand edge of the display. To choose one, press the [▶] button again. To return to a lower menu level, press the [◀] button.

Changing values

When you are at a position where it is possible to change one or more values, and your access level is high enough, you can edit the existing value, or enter a new one. After changing the value, you confirm the input with the [OK] button, or undo the change by pressing the [C]/ [▼▶] buttons for a short while until the original value reappears in the window and change mode is exited. These actions are described in detail in the following sections.

Editing an existing value

1. Press the [OK] button to go to change mode. A flashing cursor appears. If there are multiple editable values in one menu, press the [OK] button until the value you want to change flashes.
2. Move the cursor to the right and to the left with the navigation buttons [▶] and [◀].
3. The value at the cursor can now be changed in the following ways:
 - ✓ Erase the current digit or character with the [C]/ [▼▶] buttons.
 - ✓ Use the [▲] and [▼] buttons to increase or decrease the value at the cursor. Editable texts can also be changed with this method.
 - ✓ If the character at the cursor is a decimal point, you cannot browse with the [▲] and [▼] buttons. You can however erase the decimal point with the [C]/ [▼▶] buttons.
 - ✓ If the cursor is placed to the right of the value, i.e. the character at the cursor is a space, you can add a decimal point with the [▼] button, or the figure 0 with the [▲] button.
 - ✓ If you require a negative number, move the cursor to the leftmost position and press the [▼] button to get a minus sign. Then edit the following digits to the required value.
 - ✓ Scroll up [▲] and down [▼] to browse through texts when there are several texts to choose from instead of numerical values.

Press [OK] to confirm the change when the required value has been entered. Then the value you see in the window will be updated in the installation. After the value has been confirmed, the cursor will move to the next editable value in the current menu.

Logging on and off

The controller has different access levels. The choice of access level determines which menus are shown, as well as which parameters can be changed in the displayed menus.

- ✓ **Guest** level does not require logging on, and only permits changes in running mode and gives read-only access to a limited number of menus.
- ✓ **Operator** level gives the same access as Guest level, and in addition, access to change setpoints.

- Log on

1. Browse to Access Rights in the main menu and press [▶]

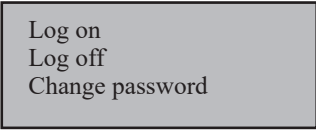

Log on
Log off
Change password

2. Select Log on and press [▶].

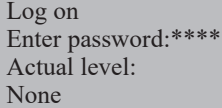

Log on
Enter password:****
Actual level:
None

3. Press [OK] to make a cursor marker appear at the first digit position.

4. Enter the password (4-digit code) by pressing [▲] until the correct digit is displayed. Press the [▶] to move to the next position. Repeat the procedure until all four digits are displayed, and press [OK] to confirm.

Note: The password for operator level is 3333. The password for the guest level is 5555.

- Log off

1. Go to Access Rights in the main menu and press [▶].

2. Select Log off and press [▶].

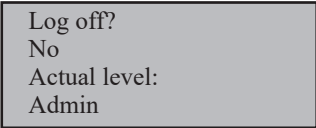

Log off?
No
Actual level:
Admin

3. Select Yes and press [OK].

Note: When logged in, the user will automatically be logged off to Guest after a settable time of inactivity (the default is 60 seconds).

Ventilation

Ventilation has up to six submenus:

Actual /Setpoint Temperature control Fan control PID controller Manual / Auto Status

- Actual/Setpoint

In this submenu, you can read all the actual values of the configured inputs of the circuit.

- Temperature control

In this submenu, you can read and set all the setpoints for the selected circuit. You need Operator or higher access level to be able to change setpoints.

Temperature Control Types

Application	Description																		
Supply air*	The supply air controller output is either a heating demand or a cooling demand depending on if the supply temperature is over or under the setpoint. Each sequence can be configured as heat, cool, exchanger, damper, compensation or not used and each sequence has its own PID-settings.																		
Supply air outdoor compensated*	<p>The supply air temperature setpoint is temperature compensated using a control curve. The temperature for compensation is configurable between all temperature sensors.</p> <p>The supply air temperature is kept at the setpoint value by controlling the output signals for sequences.</p> <table border="1"> <thead> <tr> <th>Outdoor temperature</th> <th>Setpoint supply temperature</th> </tr> </thead> <tbody> <tr> <td>-20</td> <td>25</td> </tr> <tr> <td>-15</td> <td>24</td> </tr> <tr> <td>-10</td> <td>23</td> </tr> <tr> <td>-5</td> <td>23</td> </tr> <tr> <td>0</td> <td>22</td> </tr> <tr> <td>5</td> <td>20</td> </tr> <tr> <td>10</td> <td>18</td> </tr> <tr> <td>15</td> <td>18</td> </tr> </tbody> </table>	Outdoor temperature	Setpoint supply temperature	-20	25	-15	24	-10	23	-5	23	0	22	5	20	10	18	15	18
Outdoor temperature	Setpoint supply temperature																		
-20	25																		
-15	24																		
-10	23																		
-5	23																		
0	22																		
5	20																		
10	18																		
15	18																		
Extract air cascade (default)	Cascade control of extract air temperature and supply air temperature to achieve a constant, settable room temperature. The extract air temperature is kept at the setpoint value by controlling the output signals for sequences.																		
Extract air dependent supply air*	A difference between extract air temperature and supply air temperature can be configured to maintain the supply air temperature setpoint to follow extract air temperature.																		

MENU STRUCTURE & FEATURES

Application	Description														
Extract air outdoor compensated	<p>A difference between extract air temperature and supply air temperature can be configured to maintain that the supply air temperature setpoint follows the extract air temperature.</p> <table border="1"> <caption>Data points for Extract temperature setpoint vs Outdoor temperature</caption> <thead> <tr> <th>Outdoor temperature (°C)</th> <th>Extract temperature setpoint (°C)</th> </tr> </thead> <tbody> <tr><td>-20</td><td>25</td></tr> <tr><td>-10</td><td>23</td></tr> <tr><td>-5</td><td>23</td></tr> <tr><td>0</td><td>22</td></tr> <tr><td>10</td><td>18</td></tr> <tr><td>15</td><td>18</td></tr> </tbody> </table>	Outdoor temperature (°C)	Extract temperature setpoint (°C)	-20	25	-10	23	-5	23	0	22	10	18	15	18
Outdoor temperature (°C)	Extract temperature setpoint (°C)														
-20	25														
-10	23														
-5	23														
0	22														
10	18														
15	18														

***Note:** Supply temperature sensor is not available on all unit types.

- Fan control

In this submenu, settings of the fan can be read and set. It is only visible for access level Operator and higher, and only editable for access level Service and higher.

Application	Description
Pressure	<p>Control of the fan speed using pressure transmitters.</p> <p>During pressure control, two separate analog output signals are used for supply and extract air and two separate analogue input signals for supply and extract air for pressure transmitters. The fan speeds are controlled, thereby maintaining constant pressure.</p>
Flow	<p>Instead of giving a pressure setpoint value, it is possible to use an airflow volume value in m³/h.</p> <p>The value from the pressure transmitter is recalculated to a volume flow and the fans will be controlled to give a constant flow.</p>
Manual (default)	<p>Use the manual setting if you want to manually set the speed of the fan</p> <p>Fans can be controlled at a fixed rotational speed. The rotational speed is selected by setting a fixed output signal (0 – 100%). There is one individual setpoint value for normal speed, for low speed and high speed. In this mode, pressure sensors are not needed.</p>

When running pressure/flow control or manual frequency control, it is possible to for the pressure/flow or output to be compensated. By using compensation, the fan can be run at low speed more of the time. The fan speed will increase only when necessary, thus saving energy.

This compensation can be made depending on any analog input such as supply air, extract air, room, outdoor temperature, humidity, CO₂ etc. It is possible to compensate either one or both fans at the same time. It is possible to set which fan that should be compensated, the supply or extract air fan.

The compensation can be selected to apply to both fans or one fan, to low, normal, high or all speeds or only when defrosting.

- PID control

In this submenu, the control parameters can be read and set. It is only visible for access level Operator and higher, and only editable for access level Service and higher.

Note: Changes must be made by technical personnel.

MENU STRUCTURE & FEATURES

- Manual/Auto

In this submenu, the ventilation unit can be set to manual mode. It is only visible for access level Operator and higher, and only editable for access level Service and higher.

Frequency controlled fans can be controlled at a fixed rotational speed. The rotational speed is selected by setting a fixed output signal (0 – 100%). There is one individual setpoint value for normal speed, for low speed and high speed.

Technical Specification

Variable	Read/write	Default value	Min/Max
Setpoint low speed supply air fan (%)	W	25	0/100
Setpoint low speed extract air fan (%)	W	25	0/100
Setpoint normal speed supply air fan (%)	W	50	0/100
Setpoint normal speed extract air fan (%)	W	50	0/100
Setpoint high speed supply air fan (%)	W	75	0/100
Setpoint high speed extract air fan (%)	W	75	0/100
Setpoint low speed supply air fan (Pa)	W	250	0/10000
Setpoint low speed extract air fan (Pa)	W	250	0/10000
Setpoint normal speed supply air fan (Pa)	W	500	0/10000
Setpoint normal speed extract air fan (Pa)	W	500	0/10000
Setpoint high speed supply air fan (Pa)	W	750	0/10000
Setpoint high speed extract air fan (Pa)	W	750	0/10000
Setpoint low speed supply air fan (m3/h)	W	1000	0/60000
Setpoint low speed extract air fan (m3/h)	W	1000	0/60000
Setpoint normal speed supply air fan (m3/h)	W	2000	0/60000
Setpoint normal speed extract air fan (m3/h)	W	2000	0/60000
Setpoint high speed supply air fan (m3/h)	W	3000	0/60000
Setpoint high speed extract air fan (m3/h)	W	3000	0/60000

- Status

In this submenu, the status of the ventilation unit can be read. Each function also has different sub-statuses.

Ventilation unit	<ul style="list-style-type: none"> ✓ Actual mode ✓ Schedule mode ✓ External stop ✓ Extended operation ✓ Extended operation time left (min) ✓ Manual mode HMI ✓ Manual mode HMI time left (s) ✓ Free cooling mode ✓ Night operation active last night ✓ Summer mode ✓ Fire alarm input ✓ Frost risk ✓ Internal alarm (alarm 194)
Sequence A to J	<ul style="list-style-type: none"> ✓ Analog output (%) ✓ Start ✓ Pump

Additional function

In this submenu, you can read the actual value and read/write the setpoint of a configured extra controller.

Feature	Menu path	Variable
Temperature control	Additional function ► Extra controller ► Temperature control	<ul style="list-style-type: none"> ✓ Digital start output start/stop point (%) ✓ Pump stop delay (min) ✓ Pump-kick hour (h) ✓ Pump running when outdoor temperature < (°C) ✓ Hysteresis to allow pump stop (°C)
PID settings	Additional function ► Extra controller ► PID controller	<ul style="list-style-type: none"> ✓ P-band (°C) ✓ I-time (s) ✓ D-time (s)
Manual / Auto	Additional function ► Extra controller ► Manual / Auto	<ul style="list-style-type: none"> ✓ Controller mode ✓ Manual set (%) ✓ Controller output (%) ✓ Start

Time Settings

Controller has a year-based clock function. This means that a week-schedule with holiday periods for a full year can be set. The clock has an automatic summertime/wintertime changeover.

It has individual schedules for each weekday plus a separate holiday setting. Up to 24 individual holiday periods can be configured. A holiday period can be anything from one day up to 365 days. Holiday schedules take precedence over other schedules.

Each day has up to four individual running periods. There are daily individual schedules for low speed, normal speed and high speed of the fan, each with up to four running periods.

The **Time settings** menu contains the submenus **Time schedule**, **Holiday schedule** and **Time/Date**

Time schedule,
Holiday schedule
Time/Date

- Time schedule

Fan low speed
Fan normal speed
Fan high speed
Extra time channel1
Extra time channel2
Extra time channel3
Extra time channel4

In the time schedules, four periods are available for each day of the week. Also, four periods are available for days that are configured as holidays in the holiday schedule. During the periods the assigned circuit is working with the corresponding setpoint. Outside of a period the system is off.

- Timer Low speed, Normal speed, High speed

There are sixteen separate settings menus for each timer channel, two for each weekday and two extra for holidays. Holiday schedules take precedence over other schedules.

For 24 hour running, set a period to 00:00 - 24:00.

To inactivate a period, set the time to 00:00 - 00:00. If both periods of a day are set to 00:00 - 00:00, the unit will not run at 1/1-speed that day.

Normal speed
Monday Per3-4 >
Per 1: 00:00 - 24:00
Per 2: 00:00 - 00:00

Normal speed
Monday
Per 3: 00:00 - 00:00
Per 4: 00:00 - 00:00

If you want to run the unit from one day to another, e.g. from Monday 22:00 to Tuesday 09:00, the desired running time for both must be entered.

Normal speed
Monday
Per 1: 22:00 - 24:00
Per 2: 00:00 - 00:00

Normal speed
Tuesday
Per 3: 00:00 - 09:00
Per 4: 00:00 - 00:00

Note: Should periods for the different speeds overlap, high speed takes precedence over normal speed, and normal speed takes precedence over low speed.

- Holiday Schedule

A holiday period can be any number of consecutive days from 1...365. The dates are in the format: MM:DD.

When the present date falls within a holiday period, the scheduler will use the settings for the weekday Holiday.

Name	Unit	Min	Max	Default	Description
Holiday Per.1 Start	MM:DD	01.01	31.12	00.00	The start date of holiday period 1
Holiday Per.1 End	MM:DD	01.01	31.12	00.00	The end date of holiday period 1
----	MM:DD				
Holiday Per.24 Start	MM:DD	01.01	31.12	00.00	The start date of holiday period 1
Holiday Per.24 End	MM:DD	01.01	31.12	00.00	The end date of holiday period 1

- Time/Date

This menu displays time, date and weekday, and it permits the setting of time and date.

Time is shown in 24 hour format.

Date is shown in the format YY:MM:DD.

Inputs/Outputs

In the sub menu Inputs/Outputs you can find and modify raw values and analog and digital inputs and outputs.

Raw values
Analog inputs
Digital inputs
Analog outputs
Digital outputs

Any control signal can be bound to any in- and output, the only restriction being that digital signals cannot be bound to analog inputs and vice versa. It is up to the user doing the binding to make sure that activated functions are bound to appropriate in- and outputs.

Note: The menu is adaptive and not all items will be shown, depending on previous selections.

Mode Switch

In addition to the items in the main menu, there is also an extra menu called Mode switch, that is reached by pressing ► in the main menu. The mode switch changes the operation of the system.

Mode Switch Position	
0 - Off	Manual mode Off. System is switched off. No control function.
1 - Auto	Automatic mode. Control function depending on timer and settings.
2 - Low speed	Manual mode. System is forced to low speed of the fans.
3 - Normal speed	Manual mode. System is forced to normal speed of the fans.
4 - High speed	Manual mode. System is forced to high speed of the fans.

Alarm events and alarm handling

If an alarm condition occurs, an alarm is logged in an alarm list. The list shows the type of alarm, the alarm date and time and the alarm priority (A, B or C alarm).

Alarm priorities Alarms can be given different priority levels: A alarm, B alarm, C alarm or not active. There are three digital outputs that can be used as alarm outputs: Sum alarm, Sum alarm A and Sum Alarm B/C.

✓ A, B and C alarms all activate the sum alarm output, if it has been configured.

✓ Class A alarms also activate sum alarm A, and class B/C alarms activate sum alarm B/C.

✓ Class C alarms are removed from the alarm list when the alarm input resets even if the alarm has not been acknowledged.

- Inspect alarms

Press the [ALARM] / [◀▲] alarm buttons to view alarms.

✓ If there is more than one alarm at the same time, this is indicated by up/down arrow symbols on the right side of the screen. You can browse them using the navigation buttons [▼] and [▲].

✓ Press [◀] to exit alarm management and return to the previous menu.

- Acknowledge, block and unblock alarms

- ✓ Press the [OK] button to get a menu with the available alarm actions for the currently displayed alarm.
 - ✓ Select the required alarm action with the buttons [▼] and [▲].
 - ✓ Press the [OK] button to execute the action. At the left end of the bottom display line the alarm status is shown. For active, unacknowledged alarms the space is blank. Alarms that have been reset are indicated by the text Acknowledged. Active or blocked alarms are indicated by the text Acknowledged or Blocked.
- Acknowledged alarms will remain on the alarm list until the alarm input signal resets.
Blocked alarms remain on the alarm list until the alarm has been reset and the block has been removed. New alarms of the same type will not be activated as long as the block remains.

Caution! Blocking alarms can be potentially dangerous. A high log on access level is therefore required to block alarms.

- Alarm events

In the Alarm Events menu, there is an alarm log which contains the 40 latest alarm events. The latest event is shown at the top of the list. The alarm log is only used to view alarm history, which may simplify troubleshooting of the installation.

FUNCTIONS

Exchanger Control

The type of heat exchanger used can be plate or rotor, depending on the type of device.

- Rotary Exchanger Control

Rotary exchanger function only exists on units which have rotary exchanger. Rotational speed is controlled by the a sequence. A rotation guard can be connected to the digital input Rotary exchanger alarm (Alarm 67 Rotary exchanger alarm in the Alarm status). An alarm is generated if this input is not activated at the same time as the analogue output signal is higher than 1.0 V. It is also possible to use the heat exchanger to operate on and off depending on the outdoor temperature. The function controls an Outdoor controlled heat exchanger with a digital output that is activated when the outdoor temperature drops below a set value. There is also a rotor alarm for the open-close rotor heat exchanger.

The defrost sensor or the exhaust air temperature sensor can be used as the prevention sensor. The function cycle is activated when the sensor value used for the defrost function is lower than the preset minimum temperature value. While the cycle is active, Defrost mode is shown on the display.

- Bypass Control

By-pass function only exists on units which have by-pass module. The airflow through the exchanger is controlled by a by-pass damper. The damper is controlled by the analogue output sequence or by a type of digital outputs.

It is used when filtered fresh air is desired to be supplied to indoor without passing through heat exchanger (transition seasons). By checking the outside air temperature, return air temperature and set temperature values, it is decided whether the by-pass module will be opened or not.

-Bypass Control when defrosting

The airflow through the exchanger is controlled by a by-pass damper. The damper could be proportional or On/Off controlled. Defrosting is activated either when the digital signal Defrosting is activated in Application tool or when the value of the analogue input Defrosting temperature falls below the de-icing limit (-3°C), or when the Pressure extract air value rises above the set value for the current pressure. It is deactivated when the digital signal is reset, or alternatively when the analogue signal rises above the limit value plus a settable differential. If the digital input signal Defrosting guard exchanger is activated the exchanger is blocked, it will stay blocked as long as the digital input signal is active.

Fire Alarm Function

Feature	Variable
Select operation mode when fire/smoke alarm	<ul style="list-style-type: none"> ✓ Stopped ✓ Continuous run ✓ Running via normal start/ stop conditions ✓ Supply air fan run ✓ Extract air fan run
Supply air fan setpoint type when fire/smoke alarm	<ul style="list-style-type: none"> ✓ Auto ✓ Manual setpoint ✓ Manual output ✓ Low speed setpoint ✓ Normal speed setpoint ✓ High speed setpoint
Extract air fan setpoint type when fire/smoke alarm	<ul style="list-style-type: none"> ✓ Auto ✓ Manual setpoint ✓ Manual output ✓ Low speed setpoint ✓ Normal speed setpoint ✓ High speed setpoint

Freecooling (optional function)

This function is used during the summer to cool the building night-time using cool outdoor air, thereby reducing the need for cooling during the day and saving energy.

Free cooling requires an outdoor sensor and an extract air sensor.

Free heating (optional function)

If the outdoor temperature is higher than the indoor temperature and there is a heating demand, the recovery damper will not open for recovery but instead open fully for outdoor air. This may occur during low night-time outdoor temperatures, when the room has been cooled considerably and the outside heat is rising faster than indoors. This function is activated at the same time as Free cooling.

Freeze protection (optional functions)

A defrosting sensor or an exhaust air temperature sensor can be used as a prevention sensor. It is possible to set a starting temperature in. This represents both the minimum time that the function should be active, the supply air fan (SAF) and extract air fan (EAF) compensation, as well as the minimum time before the next prevention cycle should begin. While the cycle is active, Defrosting mode is shown in the display.

- Freeze protection control is available on all sequences.

- Exhaust air fan speed adjustable during defrosting:

- ✓ Auto
- ✓ Low
- ✓ Normal
- ✓ High

Water Heating Coil

If a sequence is configured as water heating, it's possible to select if the sequence should be controlled with freeze protection and which freeze protection sensor (1...3) that should be used. The sequence is controlled by the corresponding sequence analogue output for proportional control or digital output for on/off control.

The heater return water temperature is measured using the analog input Freeze protection temperature or the digital input Freeze protection guard, depending on the selection of freeze protection. Low temperatures will generate an internal, proportional signal that is used to force the heating valve open, thereby preventing freeze-up of the heater.

When the internal signal reaches 100 % or the digital input Freeze protection guard is activated, the unit is shut down, the heating output is set to completely open mode and an alarm is activated.

Note: The unit is restarted when the alarm has been acknowledged and the temperature for the frost protection sensor has risen above Alarm limitation running mode + P-band running mode.

Note: The accessory must be added for the function.

Water Cooling Coil

If a sequence is configured as water heating, it's possible to select if the sequence should be controlled with freeze protection and which freeze protection sensor (1...3) that should be used. The sequence is controlled by the corresponding sequence analogue output for proportional control or digital output for on/off control.

Note: The accessory must be added for the function.

Electrical Preheater

Electric heating is controlled using the analogue output sequence. On activation of the digital input Overheated electric heater the unit will be shut down, either according to the stop sequence or as an emergency shutdown. The unit will restart after the alarm has been acknowledged and Overheated electric heater has reset.

The digital output Pretreatment is set to preheating when the unit is started and the outdoor temperature is below the set heating start limit (default 8°C). If the outdoor temperature exceeds the set heating start limit by more than 1°C, preheating will be stopped.

Variable	Read/Write	Default value	Min/Max
Pretreatment output	R		
Activate preheater when outdoor temperature < (°C)	W	8	-40/150
Activate precooler when outdoor temperature > (°C)	W	19	-40/150
Hysteresis (°C)	W	1	0/10
Min difference between outdoor and intake air temperature	W	1	0/20
Pretreatment block time if difference below min (h)	W	6	0/24
Min run time (min)	W	5	0/600

Note: 63- Electric heating is overheated alarm means that the fans will be immediately stopped when there is an overheating alarm, regardless of the set cool-down time. Pretreatment always starts at start-up of the unit, if the outdoor temperature so permits.

Note: The accessory must be added for the function.

Electrical Postheater

Electric heating is controlled using the analogue output sequence. On activation of the digital input Overheated electric heater the unit will be shut down, either according to the stop sequence or as an emergency shutdown. The unit will restart after the alarm has been acknowledged and Overheated electric heater has reset.

Note: 63- Electric heating is overheated alarm means that the fans will be immediately stopped when there is an overheating alarm, regardless of the set cool-down time. Pretreatment always starts at start-up of the unit, if the outdoor temperature so permits.

Note: The accessory must be added for the function.

Damper Control

The outdoor air and exhaust air ducts close-off dampers can be controlled by digital outputs. When using pressure controlled fans the digital activation signal is activated as soon as the fan has start conditions. This signal can be used to open the close-off damper.

Note: When the unit is stopped it's possible to configure a delay time before the Outdoor air damper and Exhaust air damper is closing.

✓ Outdoor air damper close delay: 0-300 seconds (Default: 0 s)

✓ Exhaust air damper close delay: 0-300 seconds (Default: 0 s)

Constant Flow Control

When running pressure/flow control, it is possible to for the pressure/flow or output to be compensated. By using compensation, the fan can be run at low speed more of the time. The fan speed will increase only when necessary, thus saving energy.

This compensation can be made depending on any analog input such as supply air, extract air, room, outdoor temperature, humidity, CO₂ etc.

It is possible to compensate either one or both fans at the same time. It is possible to set which fan that should be compensated, the supply or extract air fan.

Note: The accessory must be added for the function.

Constant Pressure Control

When running pressure/flow control, it is possible to for the pressure/flow or output to be compensated. By using compensation, the fan can be run at low speed more of the time. The fan speed will increase only when necessary, thus saving energy.

This compensation can be made depending on any analog input such as supply air, extract air, room, outdoor temperature, humidity, CO₂ etc.

It is possible to compensate either one or both fans at the same time. It is possible to set which fan that should be compensated, the supply or extract air fan.

Note: The accessory must be added for the function.

CO2 Control

Fan speeds are automatically changed based on CO2 sensors. The fan speed will increase only when necessary, thus saving energy. It is possible to compensate either one or both fans at the same time. It is possible to set which fan that should be compensated, the supply or extract air fan.

Variable	Read/Write	Default value	Min/Max
CO2 room/extract air (ppm)	R		
Setpoint mixing damper (ppm)	W	1000	0/2000

Note: The accessory must be added for the function.

Humidity

Fan speeds are automatically changed based on humidity sensors. The fan speed will increase only when necessary, thus saving energy.

It is possible to compensate either one or both fans at the same time. It is possible to set which fan that should be compensated, the supply or extract air fan.

Variable	Read/Write	Default value	Min/Max
Humidity outdoor (%rH)	R		
Humidity room/extract air (%rH)	R		
Humidity supply air (%rH)	R		
Setpoint humidity room/extract air (%rH)	W	50	0/100
Humidity control signal (%)	R		

Note: The accessory must be added for the function.

Change language

The display language can be changed either by the front display, in the web interface.

- Front display menu:

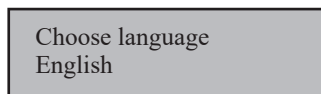

Note: This menu is also accessible by holding the [OK] button pressed during power-up or by pressing the [▶] button four times when the start display is shown.

- Web interface:

Account settings ▶ Language

Port 1 and Port 2

The controller can have one or two serial ports. In a controller with two serial ports, both ports have the same functions. However, they can not both be configured to have the same function at the same time, except that both can be slaves.

Function	Connection to	Format	Baud
EXDline slave	Application tool or SCADA system	801	9600
EXDline master	Pressure transmitters, Expansion units or Room units	801	9600
Modbus slave	SCADA system via Modbus or master controller	8N1	9600
Modbus master	Fans, Rotary exchanger, Pressure transmitters, Damper actuators and Wireless receivers	8N1	9600
BACnet MS/TP slave	BACnet SCADA or BACnet master controller	801	9600

BACnet

The controller is capable of communication via the BACnet -protocol, using either IP or MS/TP data link formats.

In order to connect a controller to a BAS (Building Automation System) via BACnet/IP, a controller with a TCP/IP port is required. To connect to a BAS via BACnet MS/TP, a controller with an RS485 communication port is required.

Note: All menus in Application tool are adaptive, which means that they adapt to the function/application you choose to set up. Therefore, not all menu items are available for all applications.

IP Configuration

IP configuration can be made in display.

The Dynamic Host Configuration Protocol (DHCP) is a network protocol used on Internet Protocol (IP) networks for dynamic distribution of network configuration parameters, such as IP addresses, DNS servers and other services.

The controller can be configured to either obtain an IP address from a DHCP server (dynamic) or the address can be set manually (static). If you wish to set a static IP address for the controller, enter the IP address you wish to use along with the subnet mask, gateway address and DNS server address.

In the display you do as follows below:

TCP/IP

DHCP: Yes
Set static IP
Running IP
-

IP
192.168.001.234
Subnet mask
255.255.255.000

Running subnet mask

-

Running gateway

-

Running DNS1

192.168.001.001

Running DNS2

192.168.001.001

BACnet List

The parameters are not available in all units, find the parameter suitable for your unit from the list.

# keyname	Object-name	Object-type	Object-instance	Description	Settable	Default	Unit-code
@DeviceName.AlaAcknowAll	AlaAcknowAll	5	10000	Command to acknowledge all alarms	Y		
@DeviceName.FilterAlarmReset	FilterAlarmReset	5	10001	Resets the filter alarm counter	Y		
@DeviceName.SumAlarm	SumAlarm	5	20007	Sumalarm	N		
@DeviceName.SumAlarmA	SumAlarmA	5	20008	A-alarm	N		
@DeviceName.SumAlarmB	SumAlarmB	5	20009	B-alarm	N		
@DeviceName.SumAlarmC	SumAlarmC	5	20010	C-alarm	N		
@DeviceName.Firealarm	Firealarm	5	20068	Fire alarm	N		
@DeviceName.RotorAlarm	RotationalGuardExchanger	5	20088	Rotor Alarm	N		
@DeviceName.Internalbatteryerror	Internalbatteryerror	5	20088	Internal battery error	N		
@DeviceName.Timeforservice	Timeforservice	5	20089	Time for service	N		
@DeviceName.Highsupplyairtemp	Highsupplyairtemp	5	20096	High supply air temp	N		
@DeviceName.Lowsupplyairtemp	Lowsupplyairtemp	5	20097	Low supply air temp	N		
@DeviceName.CommErrorDevice	CommErrorDevice	5	20202	PDT communication Alarm	N		
@DeviceName.InternalError	InternalError	5	20204	Internal error	N		
@DeviceName.DO_1	Rotor Start	Binary	20333	DO_1 (Rotay Heat Exchanger Start) 0-Close 1-Open	N		
@DeviceName.DO_3	Outdoor Air Damper Start	Binary	20335	DO_3 (Outdoor Air Damper Start) 0-Close 1-Open	N		
@DeviceName.DO_4	Running Indication	Binary	20336	DO_3 (Running Indication) 0-Closed 1-Running	N		
@DeviceName.Minute	Minute	2	30503	Minute	Y		95
@DeviceName.Hour	Hour	2	30504	Hour	Y		95
@DeviceName.WDay	WDay	2	30505	Day of Week (1-7, 1=Monday)	Y		95
@DeviceName.Week	Week	2	30506	Week number	Y		95
@DeviceName.Date	Date	2	30507	Day of month	Y		95
@DeviceName.Month	Month	2	30508	Month	Y		95

# keyname	Object-name	Object-type	Object-instance	Description	Settable	Default	Unit-code
@DeviceName.Year	Year	2	30509	Year	Y		95
VentSettings.S_DOSelect_OutdoorAirDamper	OutdoorAirDamper		30783	Running mode fresh air damper: 0 = Close, 1 = Open, 2 = Auto	Y	2	
@DeviceName.AirUnitAutoMode	AirUnitAutoMode	19	30788	Running mode air unit: 0 = Off, 1 = Manual, 2 = Auto, 3 = Low speed 4 = Normal speed, 5 = High speed	Y	3	
@DeviceName.AirUnitManual	AirUnitManual	19	30789	Manual setting for Air unit in manual mode 0 = Stop, 1 = Starting up, 2 = Low speed run, 3 = Normal speed run, 4 = High speed run, 5 = Heating support run, 6 = Cooling support run, 7 = CO2 Run, 8 = Free cool run, 9 = Fan stop run 10 = Fire run, 11 = Smoke run, 12 = Recirculation run, 13 = Delcing run	Y	0	
@DeviceName.SAFAutoMode	SAFAutoMode	19	30790	Running mode SAF: 0 = Off, 1 = Manual output, 2 = Auto, 3 = Manual setpoint, 4 = Low speed, 5 = Normal speed, 6 = High speed	Y	2	
@DeviceName.SAFManualSetpoint	SAFManualSetpoint	2	30791	Man. setp. SAF if Man. mode	Y	0	95
@DeviceName.SAFManualOutput	SAFManualOutput	2	30792	Man. output SAF if Man. mode	Y	0	98
@DeviceName.EAFAutoMode	EAFAutoMode	19	30793	Running mode EAF: 0 = Off, 1 = Manual output, 2 = Auto, 3 = Manual setpoint, 4 = Low speed, 5 = Normal speed, 6 = High speed	Y	2	
@DeviceName.EAFManualSetpoint	EAFManualSetpoint	2	30794	Man. setp. EAF if Man. mode	Y		95
@DeviceName.EAFManualOutput	EAFManualOutput	2	30795	Man. output EAF if Man. mode	Y		98
@DeviceName.SupplySetpoint	SupplySetpoint	2	30811	Setp. supply air temp. when constant supply air temp. func.	Y		(configurable)
@DeviceName.ExtractSetpoint	ExtractSetpoint	2	30812	Setp. extract air temp. if extract air temp cont. func.	Y		(configurable)
@DeviceName.SupplySetpointMax	SupplySetpointMax	2	30813	Max limit of supply setp. when cascade cont.	Y		(configurable)
@DeviceName.SupplySetpointMin	SupplySetpointMin	2	30814	Min limit of supply setp. when cascade cont.	Y		(configurable)
@DeviceName.SupplySetpOffsetLow	SupplySetpOffsetLow	2	30815	Temp. setp. Offset in low speed	Y		(configurable)
@DeviceName.SupplySetpOffsetHigh	SupplySetpOffsetHigh	2	30816	Temp. setp. Offset in high speed	Y		(configurable)
@DeviceName.SAFLowspeedAirFlow	SAFLowspeedAirFlow	2	30841	Setp. full sp. supply air fan flow.	Y		(configurable)
@DeviceName.SAFNormalspeedAirFlow	SAFNormalspeedAirFlow	2	30842	Setp. reduced sp. supply air fan flow.	Y		(configurable)

# keyname	Object-name	Object-type	Object-instance	Description	Settable	Default	Unit-code
@DeviceName. SAFHighspeedAirFlow	SAFHighspeedAirFlow	2	30843	Setp. reduced sp. supply air fan flow.	Y		(configurable)
@DeviceName. EAFLowSpeedAirFlow	EAFLowSpeedAirFlow	2	30844	Setp. reduced sp. supply air fan flow.	Y		(configurable)
@DeviceName. EAFNormalspeedAirFlow	EAFNormalspeedAirFlow	2	30845	Setp. full sp. Extract air fan flow.	Y		(configurable)
@DeviceName. EAFHighspeedAirFlow	EAFHighspeedAirFlow	2	30846	Setp. high sp. Extract air fan flow.	Y		(configurable)
@DeviceName. .SAFLowSpeedOutput	SAFLowSpeedOutput	2	30847	Output signal low speed SAF if Freq. cont. manually	Y		98
@DeviceName. SAFNormalSpeedOutput	SAFNormalSpeedOutput	2	30848	Output signal normal speed SAF if Freq. cont. manually	Y		98
@DeviceName. SAFHighspeedOutput	SAFHighspeedOutput	2	30849	Output signal high speed SAF if Freq. cont. manually	Y		98
@DeviceName. EAFLowSpeedOutput	EAFLowSpeedOutput	2	30850	Output signal low speed EAF if Freq. cont. manually	Y		98
@DeviceName. EAFNormalSpeedOutput	EAFNormalSpeedOutput	2	30851	Output signal normal speed EAF if Freq. cont. manually	Y		98
@DeviceName. EAFHighspeedOutput	EAFHighspeedOutput	2	30852	Output signal high speed EAF if Freq. cont. manually	Y		98
@DeviceName. SAFLowSpeedPressOffset	EAFHighspeedOutput	2	30853	Offset SAF press. low speed	Y		(configurable)
@DeviceName. SAFHighSpeedPressOffset	SAFHighSpeedPressOffset	2	30854	Offset SAF press. high speed	Y		(configurable)
@DeviceName. SAFLowSpeedAirFlowOffset	SAFLowSpeedAirFlowOffset	2	30855	Offset SAF air flow low speed	Y		(configurable)
@DeviceName. SAFHighSpeedAirFlowOffset	SAFHighSpeedAirFlowOffset	2	30856	Offset SAF air flow high speed	Y		(configurable)
@DeviceName. SAFLowSpeedOutputOffset	SAFLowSpeedOutputOffset	2	30857	Offset SAF output low speed	Y		98
@DeviceName. SAFHighSpeedOutputOffset	SAFHighSpeedOutputOffset	2	30858	Offset SAF output high speed	Y		98
@DeviceName. EAFLowSpeedPressOffset	EAFLowSpeedPressOffset	2	30859	Offset EAF press. low speed	Y		(configurable)
@DeviceName. EAFHighSpeedPressOffset	EAFHighSpeedPressOffset	2	30860	Offset EAF press. high speed	Y		(configurable)
@DeviceName. EAFLowSpeedAirFlowOffset	EAFHighSpeedPressOffset	2	30861	Offset EAF air flow low speed	Y		(configurable)

# keyname	Object-name	Object-type	Object-instance	Description	Settable	Default	Unit-code
@DeviceName. EAFHighSpeedAirFlowOffset	EAFHighSpeedAirFlowOffset	2	30862	Offset EAF air flow high speed	Y		(configurable)
@DeviceName. EAFLowSpeedOutputOffset	EAFLowSpeedOutputOffset	2	30863	Offset EAF output low speed	Y		98
@DeviceName. EAFHighSpeedOutputOffset	EAFHighSpeedOutputOffset	2	30864	Offset EAF output high speed	Y		98
@DeviceName.AlarmOutput	AlarmOutput	2	31000	Alarm output of configured alarm number	Y		95
@DeviceName. SupplyHighAlarmLimit	SupplyHighAlarmLimit	2	31002	High alarm limit supply air temp	Y		(configurable)
@DeviceName. SupplyLowAlarmLimit	SupplyLowAlarmLimit	2	31003	Low alarm limit supply air temp	Y		(configurable)
@DeviceName. ExtractAirTempHigh	ExtractAirTempHigh	2	31007	High alarm limit Extract air temp	Y		(configurable)
@DeviceName. ExtractAirTempLow	ExtractAirTempLow	2	31008	Low alarm limit Extract air temp	Y		(configurable)
@DeviceName. AI_OutDoorTemp	AI_OutDoorTemp	2	40290	Outdoor temp	N		(configurable)
@DeviceName. AI_SupplyAirTemp	AI_SupplyAirTemp	2	40292	Supply air temp.	N		(configurable)
@DeviceName. AI_ExhaustAirTemp	AI_ExhaustAirTemp	2	40293	Exhaust air temp	N		(configurable)
@DeviceName. AI_ExtractAirTemp	AI_ExtractAirTemp	2	40294	Extract air temp	N		(configurable)
@DeviceName. AI_SAFFlow	AI_SAFFlow	2	40313	Supply air fan flow	N		(configurable)
@DeviceName. AI_EAFFlow	AI_EAFFlow	2	40314	Extract air fan flow	N		(configurable)
@DeviceName. AI_FilterGuard1	AI_FilterGuard1	2	40335	Ana. filter 1 value	N		(configurable)
@DeviceName. SAFAirFlow	SAFAirFlow	2	40359	Counted air flow m3/h supply air	N		(configurable)
@DeviceName. EAFAirFlow	EAFAirFlow	2	40360	Counted air flow m3/h extract air	N		(configurable)
@DeviceName.AO_SeqY3	Cooling Battery	2	40365	Cooling Battery position	N		
@DeviceName.AO_SAF	AO_SAF	2	40375	Supply air fan cont.	N		98
@DeviceName.AO_EAF	AO_EAF	2	40376	Extract air fan cont.	N		98

# keyname	Object-name	Object-type	Object-instance	Description	Settable	Default	Unit-code
@DeviceName. UnitMode	UnitMode	19	40428	Run mode. 0=Stop, 1=Starting up, 2=Low speed run, 3=Normal speed run 4=High speed run, 5=Heating support run 6=Cooling support run, 7=CO2 Run 8=Free cool run, 9=Fan stop run 10=Fire run, 11=Smoke run 12=Recirculation run, 13=Delcing run	N		
@DeviceName.UnitModeControl	UnitModeControl	19	40429	Indicates what is triggering the curr. run mode Indicates what is triggering the current run mode 1= Time schedule, 2= Manual run 3= Digital Input, 4= Alarm 5= External control, 6= Service stop	N		
@DeviceName.ActiveSeqType	ActiveSeqType	19	40430	Active seq. type	N		
@DeviceName.SAFRunTime	SAFRunTime	2	40434	Run. Time supply air fan	N		71
@DeviceName.EAFRunTime	EAFRunTime	2	40435	Run. Time extract air fan	N		71
@DeviceName.SAF	SAF	2	40449	Cont. signal supply air fan	N		98
@DeviceName.EAF	EAF	2	40450	Cont. signal extract air fan	N		98
@DeviceName. SAFSpeed	SAFSpeed	19	40451	SAF speed in auto and manual mode 0= Off, 1= Low speed, 2= normal speed 3= high speed, 4= Special	N		
@DeviceName. EAFSpeed	EAFSpeed	19	40452	EAF speed, 0= Off, 1= Low speed, 2= normal speed, 3= high speed 4= Special	N		

Alarm List

Details about the alarm on the display can be found in the table.

No	Alarm text	Prio	Delay	Limit	Default action	Description
1	Malfunction supply air fan 1	B	120 s			Malfunction supply air fan 1
2	Malfunction supply air fan 2	B	120 s			Malfunction supply air fan 2
3	Malfunction supply air fan 3	B	120 s			Malfunction supply air fan 3
4	Malfunction supply air fan 4	B	120 s			Malfunction supply air fan 4
5	Malfunction supply air fan 5	B	120 s			Malfunction supply air fan 5
6	Malfunction extract air fan 1	B	120 s			Malfunction extract air fan 1
7	Malfunction extract air fan 2	B	120 s			Malfunction extract air fan 2
8	Malfunction extract air fan 3	B	120 s			Malfunction extract air fan 3
9	Malfunction extract air fan 4	B	120 s			Malfunction extract air fan 4
10	Malfunction extract air fan 5	B	120 s			Malfunction extract air fan 5
11	Alarm supply air fan 1	A	0 s			Alarm from frequency converter SAF via Modbus communication
12	Alarm supply air fan 2	A	0 s			Alarm from frequency converter SAF 2 via Modbus communication

No	Alarm text	Prio	Delay	Limit	Default action	Description
13	Alarm supply air fan 3	A	0 s			Alarm from frequency converter SAF 3 via Modbus communication
14	Alarm supply air fan 4	A	0 s			Alarm from frequency converter SAF 4 via Modbus communication
15	Alarm supply air fan 5	A	0 s			Alarm from frequency converter SAF 5 via Modbus communication
16	Alarm extract air fan 1	A	0 s			Alarm from frequency converter EAF via Modbus communication
17	Alarm extract air fan 2	A	0 s			Alarm from frequency converter EAF 2 via Modbus communication
18	Alarm extract air fan 3	A	0 s			Alarm from frequency converter EAF 3 via Modbus communication
19	Alarm extract air fan 4	A	0 s			Alarm from frequency converter EAF 4 via Modbus communication
20	Alarm extract air fan 5	A	0 s			Alarm from frequency converter EAF 5 via Modbus communication
21	Warning supply air fan 1	C	0 s			Warning from frequency converter SAF 1 via Modbus communication
22	Warning supply air fan 2	C	0 s			Warning from frequency converter SAF 2 via Modbus communication
23	Warning supply air fan 3	C	0 s			Warning from frequency converter SAF 3 via Modbus communication
24	Warning supply air fan 4	C	0 s			Warning from frequency converter SAF 4 via Modbus communication
25	Warning supply air fan 5	C	0 s			Warning from frequency converter SAF 5 via Modbus communication
26	Warning extract air fan 1	C	0 s			Warning from frequency converter EAF 1 via Modbus communication
27	Warning extract air fan 2	C	0 s			Warning from frequency converter EAF 2 via Modbus communication
28	Warning extract air fan 3	C	0 s			Warning from frequency converter EAF 3 via Modbus communication
29	Warning extract air fan 4	C	0 s			Warning from frequency converter EAF 4 via Modbus communication
30	Warning extract air fan 5	C	0 s			Warning from frequency converter EAF 5 via Modbus communication
31	External operation supply air fan	C	120 s			SAF run-signal received when unit is stopped
32	External operation extract air fan	C	120 s			EAF run-signal received when unit is stopped
35	Malfuction pump heater	B	5 s			Malfuction pump, heating circuit
36	Malfuction pump cooler	B	5 s			Malfuction pump, cooling circuit
39	Malfuction damper	B	90 s			Malfuction damper (via Modbus)
43	Malfuction sequence A	-	5 s			Malfuction sequence A
44	Malfuction sequence B	-	5 s			Malfuction sequence B
45	Malfuction sequence C	-	5 s			Malfuction sequence C
46	Malfuction sequence D	-	5 s			Malfuction sequence D
47	Malfuction sequence E	-	5 s			Malfuction sequence E
48	Malfuction sequence F	-	5 s			Malfuction sequence F
49	Malfuction sequence G	-	5 s			Malfuction sequence G
50	Malfuction sequence H	-	5 s			Malfuction sequence H
51	Malfuction sequence I	-	5 s			Malfuction sequence I
52	Malfuction sequence J	-	5 s			Malfuction sequence J
53	Filter alarm supply air	B	180 s	CURVE		Filter alarm supply air pressure switch or analogue filter switch activated. The analogue filter switch may be flow dependent.
54	Filter alarm extract air	B	180 s	CURVE		Filter alarm extract air pressure switch or analogue filter switch activated. The analogue filter switch may be flow dependent.

No	Alarm text	Prio	Delay	Limit	Default action	Description
55	Alarm low air flow	B	5 s		Normal stop	Flow switch activated
56	Freeze protection guard	A	0 s		Fast stop	External frost protection thermostat activated
57	Defrosting guard exchanger	-	0			Exchanger deicing pressure switch activated
58	Fire alarm	A	0 s		Fast stop	Fire alarm activated
60	External stop	C	0 s		Normal stop	"External stop" activated
61	External alarm	B	0 s			External alarm activated
62	Service stop	B	0 s			Service stop activated
63	Electric heating is overheated	A	0 s		Normal stop	Heater high temperature limit switch activated
64	Warning freeze protection	B	30 min	50 %		Frost protection function is overriding the control of the heater output
66	Defrosting alarm	-	2 s			Exchanger deicing activated by deicing sensor
67	Rotary exchanger alarm	B	20 s			Exchanger rotation guard alarm
68	Extra alarm 1	-	0 s			Extra alarm 1 on digital input
69	Extra alarm 2	-	0 s			Extra alarm 2 on digital input
70	Extra alarm 3	-	0 s			Extra alarm 3 on digital input
71	Extra alarm 4	-	0 s			Extra alarm 4 on digital input
72	Extra alarm 5	-	0 s			Extra alarm 5 on digital input
73	Extra alarm 6	-	0 s			Extra alarm 6 on digital input
74	Extra alarm 7	-	0 s			Extra alarm 7 on digital input
75	Extra alarm 8	-	0 s			Extra alarm 8 on digital input
76	Extra alarm 9	-	0 s			Extra alarm 9 on digital input
77	Extra alarm 10	-	5 s			Extra alarm 10 on digital input
78	Internal battery error	A	0 s			Internal battery needs replacing
79	Alarm service interval	C	0 s			Time for service
80	Restart blocked after power on	B	0 s		Fast stop	Restart blocked due to earlier power failure
81	Deviation alarm supply air temp.	B	30 min	10 °C		Supply air temp deviates too much from the setpoint
82	Deviation alarm supply air fan	-	30 min	50 Pa		Supply air pressure deviates too much from the setpoint
83	Deviation alarm extract air fan	-	30 min	50 Pa		Extract air pressure deviates too much from the setpoint
84	Deviation alarm humidity control	-	30 min	10 %		The room humidity deviates too much from the setpoint
86	High supply air temperature	B	5 s	30 °C		Supply air temp too high
87	Low supply air temperature	B	5 s	10 °C		Supply air temp too low
88	Supply air temperature max limit	-	0 s			Maximum limiting of supply air temp active
89	Supply air temperature min limit	-	0 s			Minimum limiting of supply air temp active
92	High extract air temperature	B	30min	30 °C		High extract air temp during extract air control
93	Low extract air temperature	B	30min	10 °C		Low extract air temp during extract air control
94	High outdoor air temperature	-	0 s	40 °C		Outdoor temperature is too high
95	Low outdoor air temperature	-	0 s	-30 °C		Outdoor temperature is too low
96	Freeze protection alarm 1	A	0 s		Fast stop	Frost protection temperature 1 below frost limit value

No	Alarm text	Prio	Delay	Limit	Default action	Description
97	Freeze protection alarm 2	A	0 s		Fast stop	Frost protection temperature 2 below frost limit value
98	Freeze protection alarm 3	A	0 s		Fast stop	Frost protection temperature 3 below frost limit value
113	Manual operation air handling unit	C	0 s			The unit is in manual mode
114	Manual operation supply air	C	0 s			Supply air temp controller in manual control
115	Manual operation supply air fan	C	0 s			Supply air fan in manual control
116	Manual operation extract air fan	C	0 s			Extract air fan in manual control
117	Manual operation heater	C	0 s			The heater is in manual mode
118	Manual operation exchanger	C	0 s			Heat exchanger output in manual control
119	Manual operation cooler	C	0 s			Cooling output in manual control
120	Manual operation damper	C	0 s			Damper output in manual control
121	Manual operation pump heater	C	0 s			Heating circulation pump in manual control
125	Manual operation damper outdoor air	C	0 s			Fresh air damper in manual control
128	Manual control sequence A	-	0 s			Manual control of sequence A
129	Manual control sequence B	-	0 s			Manual control of sequence B
130	Manual control sequence C	-	0 s			Manual control of sequence C
131	Manual control sequence D	-	0 s			Manual control of sequence D
132	Manual control sequence E	-	0 s			Manual control of sequence E
133	Manual control sequence F	-	0 s			Manual control of sequence F
134	Manual control sequence G	-	0 s			Manual control of sequence G
136	Manual control sequence H	-	0 s			Manual control of sequence H
137	Manual control sequence I	-	0 s			Manual control of sequence I
138	Manual control sequence J	-	0 s			Manual control of sequence J
139	Input in manual operation	C	0 s			Analogue or digital input in manual mode
143	Manual operation pretreatment	C	0 s			Pretreatment in manual mode
144	Sensor error outdoor air temperature	B	5 s			Malfunction in connected sensor
146	Sensor error supply air temperature	B	5 s			Malfunction in connected sensor
147	Sensor error exhaust air temperature	B	5 s			Malfunction in connected sensor
148	Sensor error extract air temperature	B	5 s			Malfunction in connected sensor
165	Sensor error pressure supply air	B	5 s			Malfunction in connected sensor
166	Sensor error pressure extract air	B	5 s			Malfunction in connected sensor
167	Sensor error flow supply air	B	5 s			Malfunction in connected sensor
168	Sensor error flow extract air	B	5 s			Malfunction in connected sensor
169	Sensor error flow exch. supply air	B	5 s			Malfunction in connected sensor
170	Sensor error press. exch. extr. air	B	5 s			Malfunction in connected sensor
171	Sensor error defrosting temperature	B	5 s			Malfunction in connected sensor
172	Sensor error freeze protect. temp. 1	B	5 s			Malfunction in connected sensor
173	Sensor error freeze protect. temp. 2	B	5 s			Malfunction in connected sensor

No	Alarm text	Prio	Delay	Limit	Default action	Description
174	Sensor error freeze protect. temp. 3	B	5 s			Malfunction in connected sensor
175	Sensor error CO2 room/extract air	B	5 s			Malfunction in connected sensor
176	Sensor error humidity room/ extr. air	B	5 s			Malfunction in connected sensor
177	Sensor error humidity supply air	B	5 s			Malfunction in connected sensor
178	Sensor error humidity outdoor	B	5 s			Malfunction in connected sensor
180	Signal error external control SAF	B	5 s			Malfunction in connected sensor
181	Signal error external control EAF	B	5 s			Malfunction in connected sensor
187	Sensor error external temp. setpoint	B	5 s			Malfunction in connected sensor
188	Signal error external flow setpoint	B	5 s			Malfunction in connected sensor
189	Sensor error press. filter supp. air	B	5 s			Malfunction in connected sensor
190	Sensor error press. filter extr. air	B	5 s			Malfunction in connected sensor
192	Communication fault device	C	0 s			Communication error to a device
194	Internal error	-	60 s			Internal Error

Panel Installation

- Cabling

The connection cable is available in two versions, 3 m or 10 m. If a connection cable is instead manufactured by the user, its maximum usable length is 100 m.

- Mounting

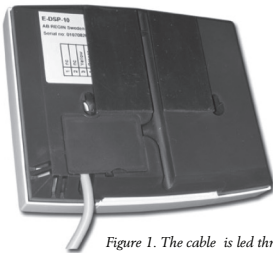

Figure 1. The cable is led through the outlet

Panel can be mounted on a wall or a device box (cc 60 mm). It can also be mounted on a cabinet front using the supplied magnetic tape. The magnetic strips are pasted onto the back of the unit. When using this mounting, the cable should be led through the alternate outlet at the bottom of the wiring compartment. See Figure 1.

It is also advisable to place a cable tie in accordance with Figure 2 in order to prevent a cable being torn from the display. E3-DSP can also be used as a hand-held terminal.

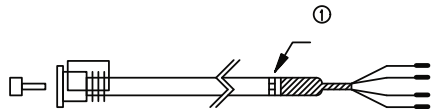
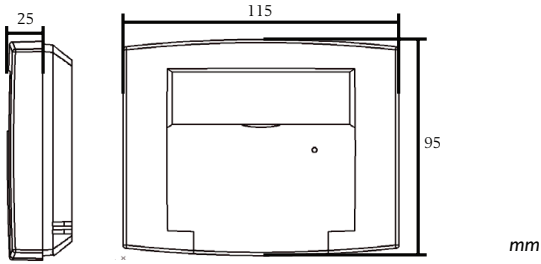
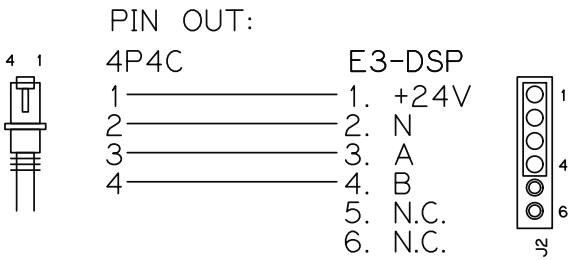

Figure 2. The cable should preferably be fixed in place using a cable tie (1)

- Dimensions



- Cable connections







www.eneko.com.tr

İSTANBUL

 Cevizli District, Zuhul Avenue, Fusun Street, Ritim Istanbul
A5 Block Floor: 25 No: 137, 34846 Maltepe/Istanbul - TURKEY

 +90 216 455 29 60 /+90 216 455 29 61

 +90 216 455 29 62

 satis@eneko.com.tr

İZMİR

 10049 Street No: 4 I.A.O.S.B.
Cigli/Izmir - TURKEY

 +90 232 328 20 80

 +90 232 328 20 22

 info@eneko.com.tr